

General Illumination

SAL-2

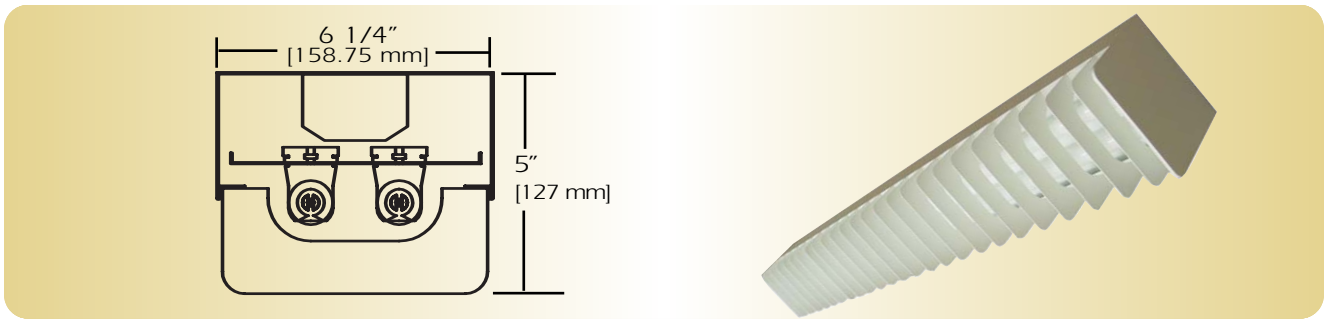

TYPE _____

FEATURES

The SAL series is a direct version of the family of stack light luminaires. It was designed to illuminate with superior vertical lumen intensity, while in open space applications. The series can be surface mounted or suspended. These luminaires can be mounted individually or in perfectly aligned continuous rows. The SAL provides an excellent solution for lighting and accenting vertical surfaces.

SPECIFICATIONS

Housing: One piece die formed 20-gauge cold rolled steel welded construction forming a 6 1/4 " x 5 " lighted baffle profile. No intermediate end caps feature creates an uninterrupted perfectly aligned continuous row. Finished end caps are welded with on exposed hardware or knockouts.

Reflector: Die formed 20-gauge cold rolled steel minimum 90% reflectivity finished in high gloss baked white enamel.

Diffuser: Standard diffuser is 2 3/8" high steel cross baffle spaced 2" on center finished in baked white enamel.

Electrical: Ballast is electronic, high power factor, thermally protected class P, sound rated A, less than 20% total harmonic distortion. The minimum number of ballast will be used unless specified.

Mounting: Standard installation is an adjustable self-locking aircraft assembly 48" x 3/32" in diameter with 5" canopy. One 16/4 SJT straight 54" cord is supplied with each power feed. Standard pendants are available in 24" lengths. See Accessories for additional mounting.

Finish: Fixture housing and steel components are finished in baked white enamel applied over a five-stage pretreatment process.

Lamps: Fixtures are provided for use with two 32 watt T8 lamp or 54 watt T5 HO lamp. (Supplied by Others).

Certification: Luminaires are U. L. Listed, C. S. A. certified and are Union Made in the United States of America. I. B. E. W.

ORDERING GUIDE

SELECT MODEL	DIRECTION	DIFFUSER	LAMPS	MOUNTING	LENGTH	FINISH	VOLTAGE	OPTIONS
SAL 2	D							
SAL 2	D= Direct	SCB= Steel Cross Baffle	232 T8 254 T5 HO	AC= Cable PD= Pendant S= Surface WM= Wall Mounted	4= Ft 8= Ft	W= White CC= Custom Color	120v 277v	See Options Below

Example: **SAL 2 -D-SCB-254T5HO-AC-4-W-120**

SAL 2 steel construction direct with cross blade baffles for two 54 watt T5 HO lamp including two 48 inch aircraft cables and power feed four foot fixture in baked white enamel 120v electronic ballast less than 20% total harmonic distortion.

OPTIONS

- E10=** Electronic ballast, high power factor, thermally protected class P, sound rated A, <10% total harmonic distortion
- DIM=** Dimming Ballast
- EPC=** Emergency Battery Pack
- ASD=** Aisle Shield
- EMC=** Emergency Circuit
- TCW=** Two Circuit Wiring
- TDW=** Tandem Wiring
- OTH=** See Accessory Section for other options available

LINEAR SECTIONS AND SUSPENSION LOCATION

WALL MOUNTING

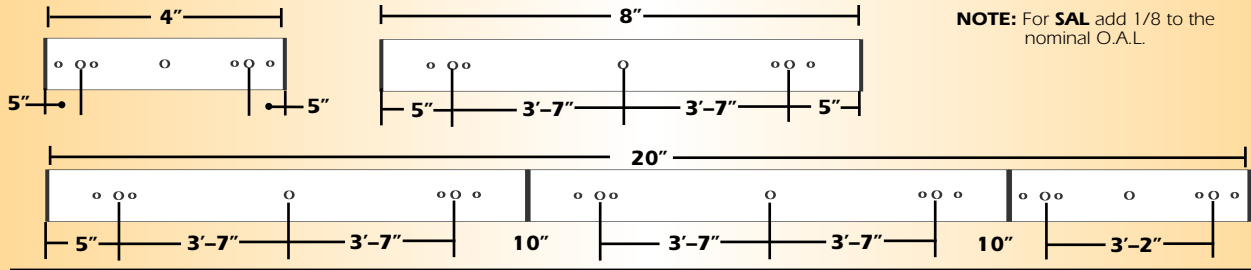

NOTE: For SAL add 1/8 to the nominal O.A.L.

CORNERS

Corners and fixture extensions are custom fabricated to precise dimensions. Please indicate the specific requirements on the layout.

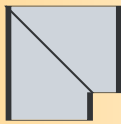

C2
90° Corner

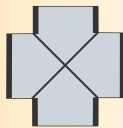

C4
4-Way Corner (Cross)

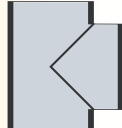

C3
3-Way Corner (Tee)

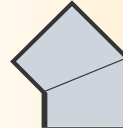

()° AC
Angular Corner

For any angular corner, ()° must be specified and dimensions must be included on the layout

For any pattern, a layout must accompany the order.

INSTALLATION PREPARATION

SAL 2 JOINT DETAIL [SECURED WITH SCREWS AND NUTS]

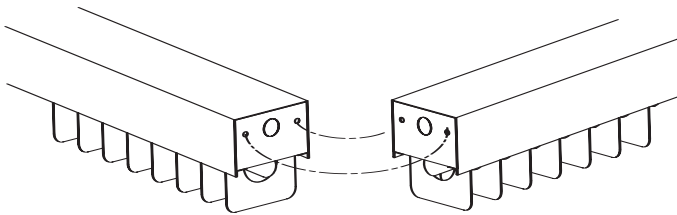

WALL INSTALLATION

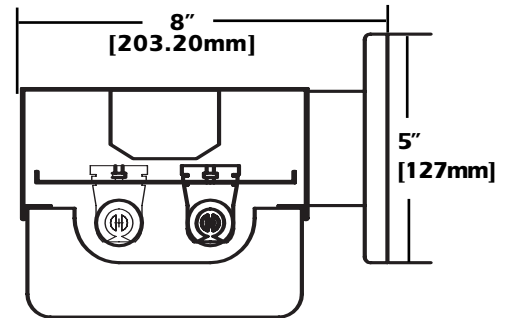

PHOTOMETRY

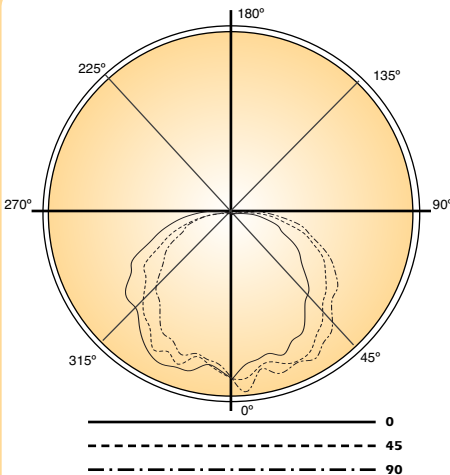

LAMP (2) 32W T8
LUMENS: 2900 PER LAMP

Candela Distribution:

Vert. Angle	0	22.5	45	67.5	90
0	1199	1199	1199	1199	1199
5	1192	1059	1120	1217	1278
10	1163	1145	1125	1207	1124
15	1143	1187	1213	1237	1202
20	1105	1162	1198	1279	1336
25	1096	1101	1205	1273	1290
30	991	1112	1215	1317	1338
35	932	1044	1124	1209	1221
40	900	972	1069	1087	1149
45	809	902	1012	1075	1112
50	709	818	952	993	1042
55	623	757	860	964	1015
60	541	645	797	892	948
65	459	583	730	832	813
70	354	497	649	703	730
75	260	437	527	617	626
80	179	321	415	506	521
85	73.1	200	319	394	410
90	20.5	99.7	208	267	288

Optical Distribution:
100% Direct

Coefficients of Utilization - Zonal Cavity Method:

pfc = 0.20

	.8	.7	.5	.3	.1	0												
pcc	.8	.7	.5	.3	.1	0												
pw	.7	.5	.3	.1	.5	.3	.1	.5	.3	.1	0							
RCR																		
0	95	95	95	95	93	93	93	93	88	88	88	84	84	84	80	80	80	78
1	85	80	76	72	82	78	74	71	74	71	68	71	68	66	67	65	63	61
2	76	69	62	57	74	67	61	56	64	59	54	61	56	53	58	54	51	49
3	69	59	52	46	67	58	51	46	55	49	45	53	48	44	50	46	42	40
4	63	52	44	39	61	51	44	38	49	42	37	46	41	37	44	40	36	34
5	57	46	38	33	55	45	38	32	43	37	32	41	36	31	40	35	31	29
6	53	41	34	28	51	40	33	28	39	32	27	37	31	27	36	31	27	25
7	49	37	30	25	47	37	29	24	35	29	24	34	28	24	32	27	23	22
8	45	34	27	22	44	33	26	22	32	26	21	31	25	21	30	24	21	19
9	42	31	24	19	41	30	24	19	29	23	19	28	23	19	27	22	19	17
10	40	28	22	17	38	28	22	17	27	21	17	26	21	17	25	20	17	15

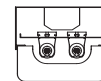

Total Luminaire Optical Efficiency = 80.6%