

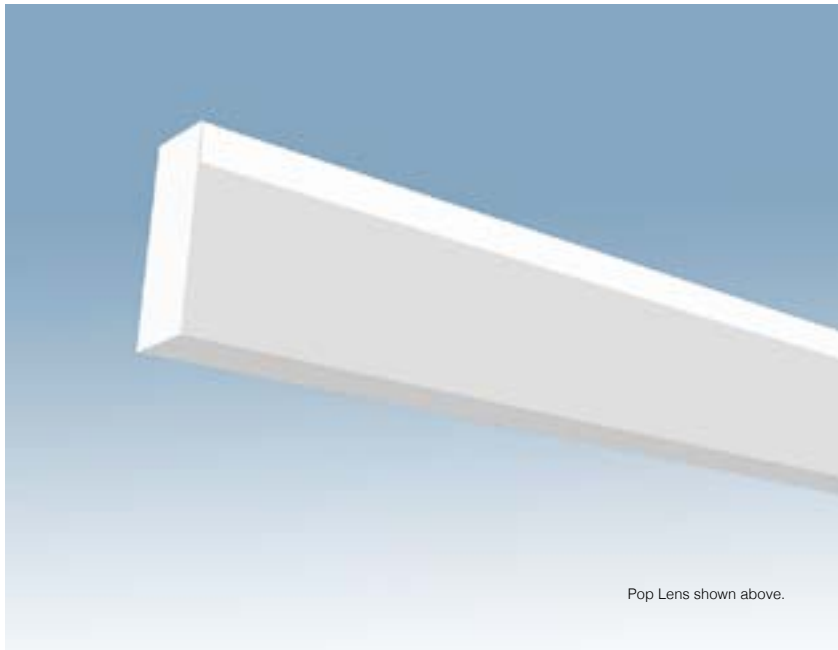

Profile Series | PRFL-24-I-WM
LED Luminaire



DATE	NOTES
PROJECT	
TYPE	



Pop Lens shown above.

- HOUSING:** Extruded aluminum housing.
- REFLECTOR:** Extruded aluminum finished in highly reflective baked white enamel.
- SHIELDING:** LED optimized Satin Ice (SI) acrylic regressed, opal acrylic flush (FL) and opal acrylic pop (PL) lenses are available. Clear acrylic (CA) standard.
- LEDS:** LED modules in 30/35/40 & 50K CCT, 80 CRI (90CRI available). Lumen maintenance minimum L_{70} = 50,000 hours. 3 SDCM color consistency.
- ELECTRICAL:** Pre-wired Class 2 AOC electronic driver, 120/277V input, PF > 90%, THD < 20 @ 120V. 0-10V dimming to 1%. -20C to +50C operating range.
- MOUNTING:** Provided with wall mounting brackets measuring 4" square by 1/4" deep. Finished in baked white enamel to match housing.
- FINISH:** Housing and components finished in baked white enamel. Canopies and pendant stems are white enamel unless otherwise specified.
- CERTIFICATION:** Luminaires are cETLus listed conforming to UL STD. 1598 and certified to CSA STD C22.2 NO. 250.0. Suitable for dry & damp locations. Union Made in the United States of America. I.B.E.W. RoHS compliant.
- PERFORMANCE:** DLC V4.3 Qualified luminaire; minimum 105 LPW efficacy. U.S DOE Lighting Facts[®] certified. Search for additional Day-O-Lite qualified luminaires at www.designlights.org. See available DLC options and ordering instructions on page 2.

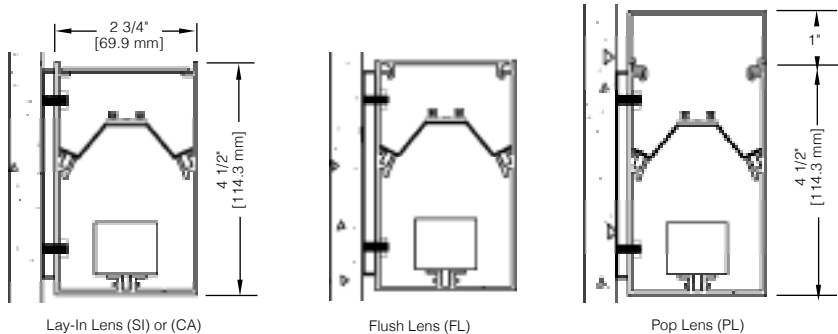

Ordering Guide (choose from the lists below and specify)

MODEL	STYLE	DISTRIB.	SHIELDING	COLOR TEMP (CCT) ¹	DELIVERED LUMENS ²	NOMINAL SIZE ³	MOUNTING	FINISH	OPTIONS ⁴
PRFL	24	I					WM		
PRFL	24	I = Indirect	CA = Clear Acrylic (lay-in) SI = Satin Ice Acrylic Regressed (lay-in) FL = Flush Opal Acrylic (snap-in) PL = Pop Opal Acrylic (snap-in)	30 = 3000K 35 = 3500K 40 = 4000K 50 = 5000K (80CRI standard, 90CRI optional.)	LO = 675/ft (5W/ft, 123LPW) SO = 900/ft (7W/ft, 129LPW) (w/CA lens. See page 2 for DLC performance.)	4 = 4 ft 6 = 6 ft 8 = 8 ft For other enter row length (e.g. 48 = 48 ft)	WM = Wall Mount	W = White CC = Custom Color	DIM10 = 0-10V 1% Dimming DIMSR = Sensor Ready (5.0%) ESN = Philips™ EasySense Wireless Daylight & Occupancy Sensor for sensor ready driver. EPC4 = 4W Emergency Pack Tunable White (page 3) Acoustical Tiling (page 4)

¹80CRI standard, 90CRI available. LM-80 data available on request. Consult factory for 2700K CCT and RGB/W color changing options.
²Delivered Lumens are Standard Output (SO) and Low Output (LO) at 80+CRI 4000K CCT with Clear Acrylic lens (CA). Use the following multiplier to estimate delivered lumens at other CCTs: 2700K = 0.94, 3000K = 0.96, 3500K = 0.98, 5000K = 1.02. All values nominal.
³See page 2 for actual fixture lengths and suspension locations.
⁴See page 2 for the complete list of LED options including Lutron™, emergency battery back-up (EPC) and other driver/control options.



LED Options

0-10V DIMMING DRIVERS

DIM10 = 0-10V (1.0%)¹
 DIMSR = Sensor Ready (5.0%)²
 DIMST = Step Dimming (40%/100%)
 DALI = Digital Addressable Lighting Interface

LUTRON™ DIMMING DRIVERS

LDE1 = Hi-Lume™ 1%-H EcoSystem™
 LDE5 = 5-Series 5% EcoSystem™
 LTEA2W = Hi-Lume™ 1% 2-Wire FFC

LUTRON™ WIRELESS MODULES (Remote Mount Only)

FCJECO = EcoSystem™ Wireless RF
 Fixture Module for EcoSystem™ LED drivers.
 FCJ010 = EcoSystem™ Wireless RF
 Fixture Module for 0-10V products by others.

EMERGENCY BATTERY PACK (EPC)³ & WIRING OPTIONS

EPC4 = (4W) 400 Delivered Lumens
 EPC7 = (7W) 700 Delivered Lumens
 EPC10 = (10W) 1000 Delivered Lumens
 EPC12 = (12W) 1200 Delivered Lumens
 GTD = Generator Transfer Device
 EMC = Emergency Circuit

SENSOR⁴ OPTIONS

ESN = Philips™ EasySense⁴
 DAY = Daylight Harvesting Sensor
 OCC = Occupancy Sensor

ADDITIONAL OPTIONS

Tunable White (page 3)
 Acoustic Tiling (page 4)
 RGB/W Contact Factory⁵
 9CR = 90 CRI

DLC OPTIONS

DLC available in all lens types, sizes, mountings, finishes, DIM10, DIMSR, ESN, EPCX and EMC in the following Standard Output (SO), 80CRI lumen packages only. Please note "DLC" on all RFQs and orders where DLC is desired.

SO 3000K = 850/ft, 7W/ft, 121LPW
 SO 3500K = 880/ft, 7W/ft, 125LPW
 SO 4000K = 900/ft, 7W.ft, 128LPW

OPTIONS NOTES:

¹Standard 0-10V 1% with linear dimming curve. Add "LOG" to option code for 0-10V 1% logarithmic dimming curve.
²Philips™ Xitanium™ Sensor Ready driver for use w/integrated wireless sensors including Philips™ EasySense™, Enlighted™, EnOcean™, Digital Lumens™ and others.
³EPC performance shown with SI lens options.
⁴Philips EasySense wireless daylight/occupany sensor.
⁵RGB/W color changing options available. Contact Day-O-Lite for details.

Linear Sections and Mounting Locations

NOMINAL LENGTH	ACTUAL LENGTH	WALL BRKTS.	WALL O.C.
4'	44 1/2"	2	34 1/2"
6'	66 3/4"	3	28 3/8"
8'	89"	3	39 1/2"
12'	133 1/2"		
16'	178"		
20'	222 1/2"		

DIMENSIONS shown are for wall mount configurations. Fixtures are continuously illuminated along entire length. Rows are continuously illuminated and joined with included aligner brackets and hardware.

CORNERS & JOINERS are custom fabricated to precise dimensions. Please indicate the specific requirements on the layout. For any angular corner, (°) must be specified and dimensions must be included on the layout.

CORNERS (Illuminated)

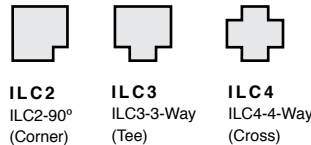

JOINER BOXES (unIlluminated)

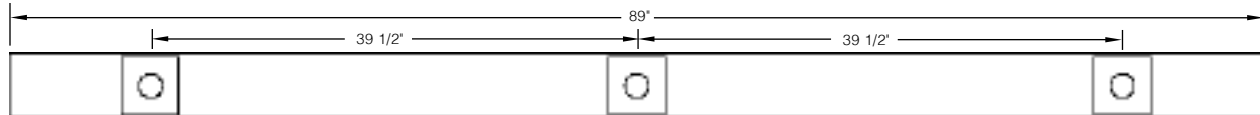
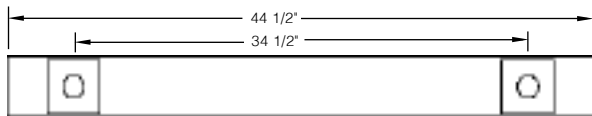
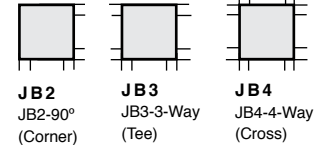

Photometry

PROL-24-I-CA-40-SO-4
Clear Dust Cover

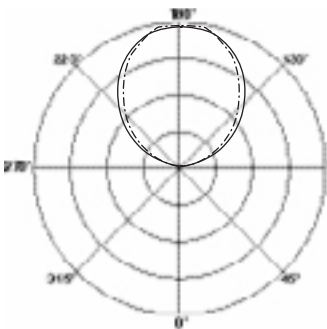

4000K CCT
 WATTS: 28
 LUMENS: 3608
 LPW: 129
 Optical Distribution:
 100% Indirect

PRFL-24-I-SI-40-SO-4
Lay-In Lens

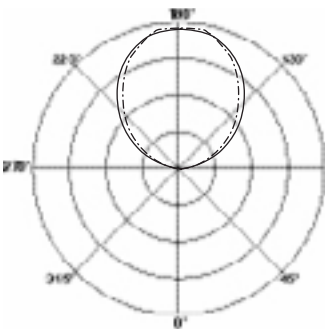

4000K CCT
 WATTS: 28
 LUMENS: 3258
 LPW: 116
 Optical Distribution:
 100% Indirect

PRFL-24-I-FL-40-SO-4
Flush Lens

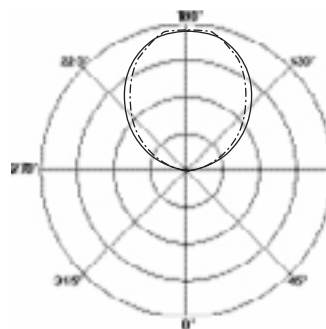

4000K CCT
 WATTS: 28
 LUMENS: 3010
 LPW: 107
 Optical Distribution:
 100% Indirect

PRFL-24-I-PL-40-SO-4-WM
Pop Lens

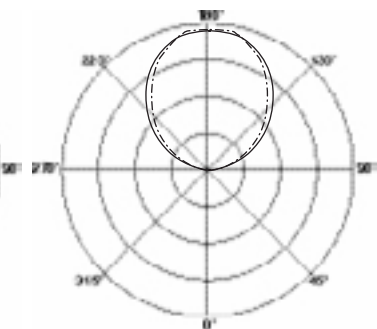

4000K CCT
 WATTS: 28
 LUMENS: Consult Factory
 LPW: Consult Factory
 Optical Distribution:
 100% Indirect

For complete photometrics and .IES files please visit the PRFL-24-I-WM page at www.dayolite.com

White Tuning

Day-O-Lite offers a variety of white tuning options and control protocols for a range of human centric applications and budgets. It is recommended that a recognized authority on the benefits, best practices and control of white tuning be consulted. Contact Day-O-Lite for additional information.

As a rule fewer channels will provide a basic level of performance for budget conscious applications. Conversely, an increased number of channels, a wider CCT range, higher CRI and more precise color consistency may be more appropriate depending on the application and desired results.

This becomes apparent when considering the black body curve within the standard CIE chromaticity diagram. Two connected CCT points, one high and one low will define a line drawn beneath the black body locus. Colors on the locus above the line will not be generated by a two channel system. In contrast, three or more channels will more accurately match the locus, resulting in greater color accuracy from the high to the low end of the range.

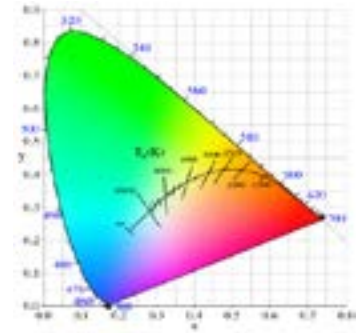

2-CHANNEL WHITE TUNING OPTIONS

2DIM10 = 0-10V 2-channel driver (1%)
1000 lumens/ft. @ 4000K, 8W/ft. nominal
2700K-6500K white tuning range
80+ CRI, 3 SDCM color accuracy

2DMX = DMX 2-channel driver (1%)
1000 lumens/ft. @ 4000K, 9W/ft. nominal
80+ CRI, 3 SDCM color accuracy

2DLM = Wattstopper® Digital Lighting Management
Blanco-2® 2700K-6500K (4000K mid-point)
1000 lumens/ft. @ 4000K, 10W/ft. nominal
80+ CRI 3 SDCM color accuracy

HOW TO SPECIFY

1. Select from the various channel/control options to the left and insert desired ordering code into the **COLOR TEMP** column of the Ordering Guide on page 1. No need to add a dimming option as the codes to the left include the chosen protocol.
2. Select the **SO** option in the **DELIVERED LUMENS** column.
3. Your luminaire will be built to the chosen system and control protocol. Controls available by Others.

3-CHANNEL WHITE TUNING OPTIONS

3DMX = eldoLED® POWERdrive™ 561/M Driver
Luxtech® LED array 2700K-6500K (variable)
1000 lumens/ft. @ 4000K, 9W/ft. nominal
80+ CRI, 3 SDCM color accuracy

3DLM = Wattstopper® Digital Lighting Management™
Blanco-3® 2700K-6500K (4000K mid-point)
1000 lumens/ft. @ 4000K
9W/ft. nominal
90+ CRI, 2 SDCM color accuracy

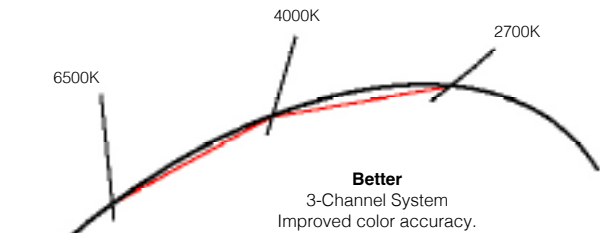
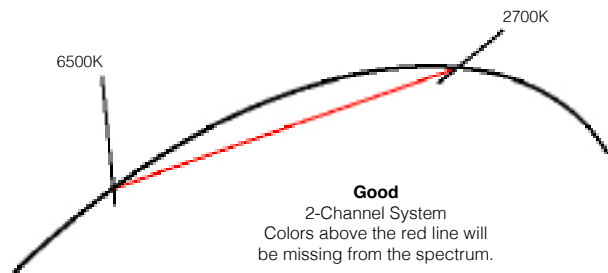

5-CHANNEL TUNABLE COLOR

LX10 = Lumenetix® araya⁵™ system, Bluetooth & 0-10V compatible
LXDX = Lumenetix araya⁵ system, Bluetooth & DMX compatible
LXDL = Lumenetix araya⁵ system, Bluetooth & DLM* compatible
LXLT = Lumenetix araya⁵ system, Bluetooth & Lutron® EcoSystem™
Lumenetix araya⁵ Tunable Color System
RGB/W+ color mixing
1650K-8000K color temperature range
CCT, intensity, hue and saturation control
1000 lumens/ft. @4000K
10W/ft. nominal
92+ CRI
2 SDCM color accuracy
ALM - araya⁵ logic module (120/277V)
Bluetooth equipped for use w/araya⁵ iOS App (free)
*Wattstopper® Digital Lighting Management

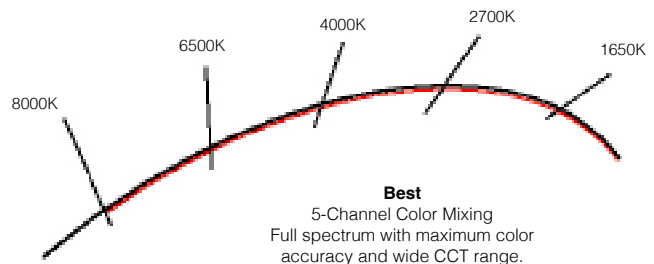

Day-O-Lite makes no claims as to the psychological or physiological efficacy of the white color tuning options offered herein.

Acoustic Options

PRFL-24-D is available with a range of acoustic tiling options. Zintra® Acoustic 1/2" Panels are the perfect solution for your application where sound reduction as well as aesthetics are required. Zintra's® wide range of colors and ease of use make it the ideal material for commercial, hospitality, educational and institutional projects.

- MATERIAL:** 100% Polyester with matte surface finish
1/2" thick panels available in 16 standard colors
Color uniform throughout
- COLOR FASTNESS:** In accordance with AATCC 16.3 option 3 color change at 20 FU = 4.5
- SOUND ABSORPTION:** 1.05 NRC (Noise Reduction Coefficient)
- FIRE RATING:** ASTM-E84 Class A Fire Rating
- SUITABLE APPLICATION:** Interior dry locations
- CARE INSTRUCTIONS:** Vacuum to remove dust
Remove spills immediately using a clean damp cloth or with soap and water
Carpet and fabric cleaners can be used – always test an inconspicuous area first
Stain repellent coating available for additional protection

COLORS:



HOW TO SPECIFY:

To specify acoustic tiling simply add ordering codes to the right to the end of the part number configurator (page 1). Tiling may be specified in 8", 12" and 16" heights, and for individual fixtures 2' to 8' long or continuous rows of any length in 1' nominal increments.

Tiles come pre-affixed to luminaire. No additional assembly is required. Standard lens options are SI = Satin Ice Acrylic Regressed (lay-in) or FL = Flush Opal Acrylic (snap-in) only. All other ordering options apply.

Contact Day-O-Lite for pricing, leadtimes and for non-luminaire filler panels and mounting hardware.

NRC COMPARISON*

FREQ. Hz	100	200	400	500	630	800	1000	1250	1600	2000	2500	3150	4000	ā	NRC
0mm/0"	0.03	0.04	0.12	0.25	0.32	0.49	0.61	0.72	0.82	0.85	0.91	0.94	0.95	0.44	0.45
50mm/2"	0.20	0.32	0.63	0.80	0.89	1.03	1.04	0.99	1.07	1.00	0.93	0.87	0.92	0.81	0.80
150mm/6"	0.29	0.57	0.97	0.96	0.91	1.04	0.92	0.88	0.94	0.94	0.91	0.90	0.91	0.97	0.90

Data is per Frequency/Hz in distance from wall for 1/2" material only. Consult factor for fixture data.

Ordering Guide (choose from the lists below)

OPTIONS	HEIGHT	COLOR
ACT		
ACT = Acoustic Tile	8 = 8" 12 = 12" 16 = 16"	FR = Frost CH = Chambray IV = Ivory SM = Smoke PE = Pewter SL = Slate TR = Tar EC = Ecrú LN = Linen SS = Sunshine MD = Mandarin OC = Ocre SK = Sky CO = Cobalt GR = Grass BK = Bark