



Stylite Series | STYSL

Date		Notes
Project		
Type	Qty	

Features

- Die-formed steel housing w/welded end-plates.
- LED optimized optics for smooth, efficient illumination.
- Individual fixtures, continuous rows or custom patterns.
- Programmable driver for custom lumen packages.
- 0-10V dimming to 1% standard. Dim-to-off available.
- DMX, Lutron and DALI protocols also available.
- Sensor Ready for wireless Smart Lighting Solutions.
- 80/90CRI, Tunable White, RGBW & RGBWW.
- Bios SkyBlue™ circadian solutions available.
- Declare Red List Approved.**

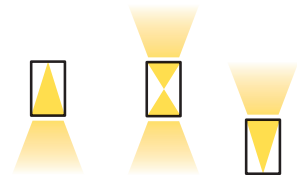
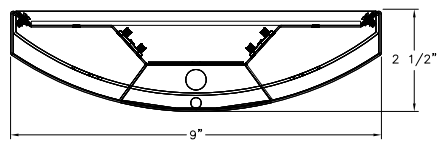
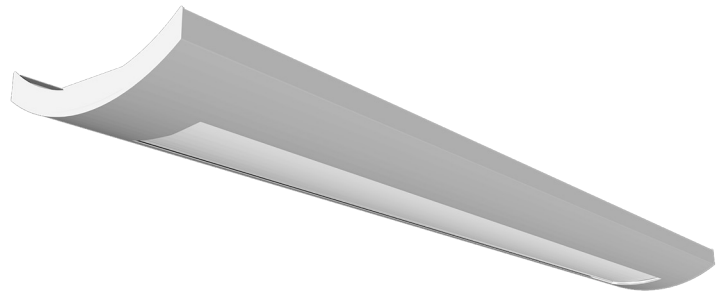

Ordering Guide



MODEL	OPTICS	CCT ¹	LUMENS ²	SIZE	MOUNTING ³	FINISH	OPTIONS
STYSL-XX	WOA						
STYSL Direct/Indirect	WOA = White Opal Acrylic	STATIC WHITE 27 = 2700K 30 = 3000K 35 = 3500K 40 = 4000K 50 = 5000K	LO = 370/ft Direct 1110/ft Indirect (11W/ft, 135LPW)	4 = 4 ft 6 = 6 ft 8 = 8 ft	ACY = Aircraft Y-Cable	W = White	DIMMING DRIVERS DIM10 = 0-10V (1%) Standard DTO = 0-10V (Dim-to-Off) DIMST = 0-10V Step Dimming DIMSR = DALI Sensor Ready (5.0%) DALI = DALI (5.0%) DMX = DMX
Select distribution below	w/clear acrylic dust covers on indirect if applicable.	BIOS SkyBlue Spectrally optimized circadian solutions.	SO = 470/ft Direct 1500/ft Indirect (14W/ft, 133LPW)	For other enter row length (e.g. 48 = 48 ft)	PD = Pendant Stem	CC = Custom Color	LUTRON™ DIMMING DRIVERS LDE1 = Hi-Lume 1% EcoSystem LD2 = Digital 1% (DALI-2) L3DA3W = Hi-Lume 1% 3-Wire
1DI = 2R-STD		TUNABLE WHITE (2700K-6500K)	HO = 470/ft Direct 1500/ft Indirect (18W/ft, 129LPW)			AMW = Anti-Microbial White	SENSORS & CONTROLS⁴ AVO = Avi-On Sensor AWNS = Lutron Athena Sensor ESN = EasySense Sensor CAS = Casambi Wireless Control
2DI = 2R-1U1D		DIM-TO-WARM (2700K-6500K) DTW = Dim-to-Warm	Above for 1DI distribution ONLY . See page 3 for all distributions and lumen packages.				EMERGENCY⁵ EMC = Emergency Circuit GTD = Generator Transfer Device EPC4 = 4W Emergency Battery EPC6 = 6.5W Emergency Battery EPC10 = 10W Emergency Battery EPC12 = 12W Emergency Battery
3I = 1R-1U		RGB & WHITE RGB = RGB RGBW = RGBW RGBWW = RGBWW (2700K-6500K)	CUSTOM Specify < HO.				WIRING & OTHER TCW = Two Circuit Wiring FWH = Flexible Wiring Harness DWH = DMX Wiring Harness
4DI = 3R-2U1D							
5I = 2R-2U							
6D = 2R-2D							
7DIS = 1R-1D							
See page 3 for details of all distribution options.							

¹All LED, BIOS, Tunable White, DTW, and RGB/W options and Ordering Codes page 2.

²Lumens at 80CRI, 4000K, WOA lens. Photometry page 4. Custom lumens may be specified below HO.

³See page 5 for all mounting options.

⁴All Sensor & Control options page 2.

⁵EPC6 is standard unless otherwise specified. EPC not for DMX drivers.

BAA letter of compliance available at www.dayolite.com.

LED, BIOS, Sensor & Control Ordering Codes

LED

Static White

30 = 3000K 80 CRI
 35 = 3500K 80 CRI
 40 = 4000K 80 CRI
 50 = 5000K 80 CRI

927 = 2700K 90 CRI
 930 = 3000K 90 CRI
 935 = 3500K 90 CRI
 940 = 4000K 90 CRI

Tunable White¹ (2700K-6500K)

2DIM10 = 0-10V 80 CRI
 2DMX = DMX 80 CRI
 2CAS = Casambi Wireless 80 CRI
 2ESN = Philips EasySense 80 CRI
 2LUT = Lutron (LD2) 80 CRI

92DIM10 = 0-10V 90 CRI
 92DMX = DMX 90 CRI
 92CAS = Casambi Wireless 90 CRI
 92ESN = Philips EasySense 90 CRI
 92LUT = Lutron (LD2) 90 CRI

Dim-to-Warm²

DTW = 6500K-2700K 80 CRI
 9DTW = 6500K-2700K 90 CRI

RGB/W³

RGB = RGB only
 RGB27 = RGB w/2700K
 RGB30 = RGB w/3000K
 RGB35 = RGB W/3500K
 RGB40 = RGB w/4000K
 RGB50 = RGB w/5000K
 RGBWW = RGB w/2700K-6500K

Single Color

RED = Red
 BLU = Blue
 GRN = Green
 AMB = Amber

BIOS SkyBlue



BIOS SkyBlue biological technology brings the benefits of blue skies inside. BIOS SkyBlue is the only spectrally optimized circadian solution to target the region that drives wellness benefits including: increased alertness, enhanced productivity, better mood, and better sleep. More information may be found at www.bioslighting.com or by contacting Day-O-Lite directly. All options for 0-10V control.

BIOS Biological Static

For daytime applications. BIOS Static Biological LED features key BIOS SkyBlue (490nm) for maximum daytime circadian impact.

B30 = 3000K
 B35 = 3500K
 B40 = 4000K

BIOS Biological Dynamic White

Designed to transition from daytime to evening in a dim-to-warm protocol. The daytime CCT includes full BIOS SkyBlue (490nm) for maximum daytime circadian impact, while the evening spectrum removes BIOS SkyBlue for minimal circadian stimulus after hours.

B30D = 3000K-2700K
 B35D = 3500K-3000K
 B40D = 4000K-3500K

BIOS Biological Tunable White

Designed to transition from daytime to evening in a tunable white protocol. The daytime CCT includes full BIOS SkyBlue (490nm) for maximum daytime circadian impact, while the evening spectrum removes BIOS SkyBlue for minimal circadian stimulus after hours.

B30T = 3000K-2700K
 B35T = 3500K-2700K
 B40T = 4000K-2700K

Sensors & Controls

Sensors

AVO = Avi-On Occ/Day
 AVM = Avi-On Occ (Microwave)
 BNV = BubblyNet Occ/Day
 ENC = Encelium Occ/Day
 ENL = EnLighted Occ/Day/Temp
 LEG = Legrand Occ/Day
 ANW = Lutron Athena Occ/Day
 VIVE = Lutron Vive Occ/Day
 NLT = Acuity nLight Occ/Day
 NXC = Current NX Occ/Day
 ESN = Philips EasySense Occ/Day
 WWL = Cooper WaveLinX Occ/Day

Wireless Control

CAS = Casambi

Sensors and control options to be commissioned wirelessly in the field by qualified controls personnel with applicable apps (by others).

Other Options

Other sensor and wireless control options are available. Contact factory for details.

¹Tunable white may be controlled by a number of dimming protocols as shown.

²Dim-to-Warm mimics incandescent dimming by warming the CCT from 6500K to 2700K as light levels are dimmed.

³All RGB, RGBW and RGBWW options for DMX control (by others). 80 CRI standard.

Individual Fixtures & Continuous Rows

NOMINAL LENGTH	ACTUAL LENGTH	SUSP. 1 O.C.	SUSP. 2 O.C.	SUSP. 3 O.C.
4'	4' 2"	4'		
8'	8' 2"	8'		
12'	12' 2"	8'	4'	
16'	16' 2"	8'	8'	
20'	20' 2"	8'	8'	4'
24'	24' 2"	8'	8'	8'

Power feed and suspension locations shown below. Continuous rows longer than 8' including EPC/EMC and sensor locations must be approved prior to manufacturing.

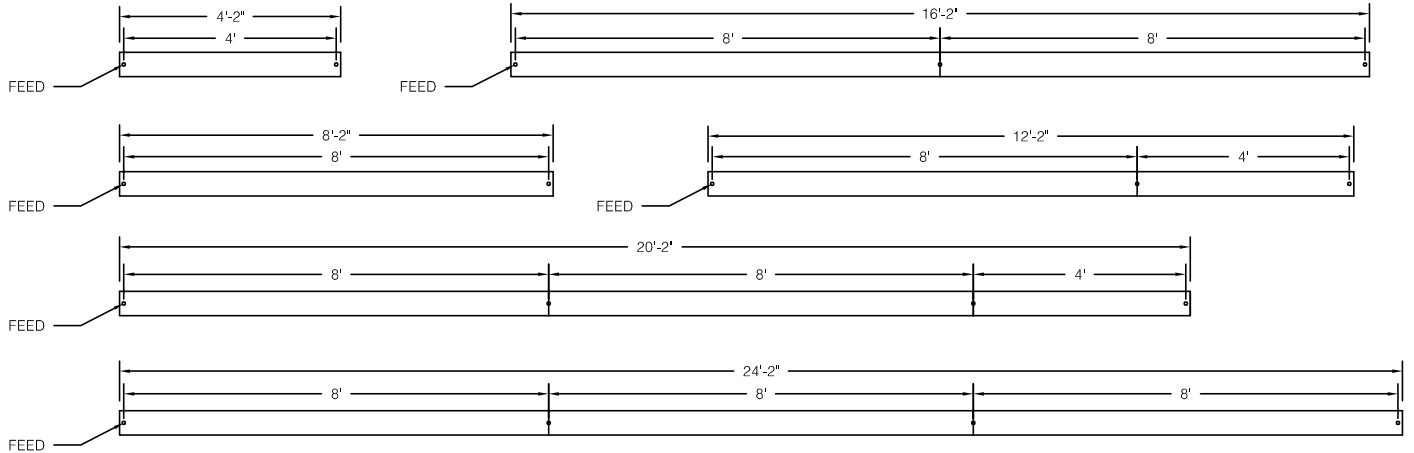

Emergency & Sensor Locations

EPC will control entire length of individual fixtures. Individual fixtures of differing lengths will deliver the same lumens under EPC power (a 4' fixture will deliver the same total lumens over half the length of an 8' fixture). EMC controlled individual fixtures will deliver lumens per foot as originally specified, unless dimmed at time of power loss. Consult factory for EMC dimming override device.



For individual fixtures to 8' EPC/EMC will power entire fixture.

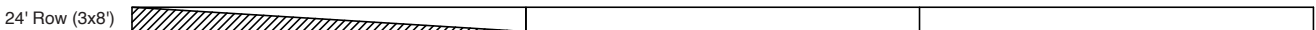

For continuous rows longer than 8' one EPC/EMC will be located in the feed section (end-left) of the row as shown below.



If two EPC/EMC's are required their default locations will be in the feed section (end-left) and last section (end-right) as below.



Custom placement of one or more EPC/EMC's must be clearly identified during ordering.



SENSORS (Integral) for individual fixtures will control entire length of fixture and will be located on feed end of fixture.

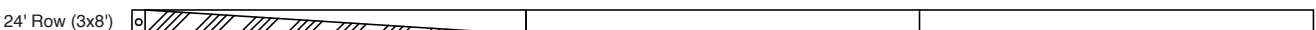

SENSORS for rows by default will control the feed section (end-left) of the row. Sensors can control more than an 8' section within a row. Consult factory for sensor/section options, or for multiple sensors in a continuous row.

Distribution Options

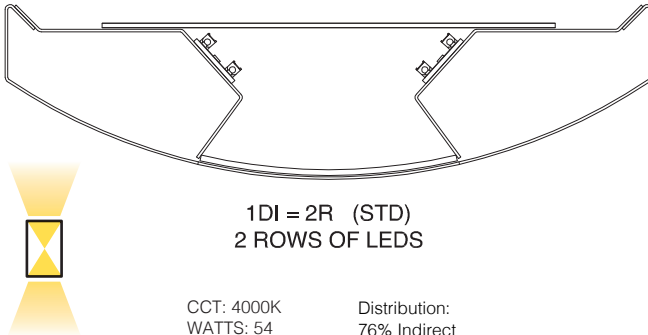

1DI = 2R (STD)
2 ROWS OF LEDS

CCT: 4000K Distribution:
WATTS: 54 76% Indirect
LUMENS: 7225 24% Direct
LPW: 133

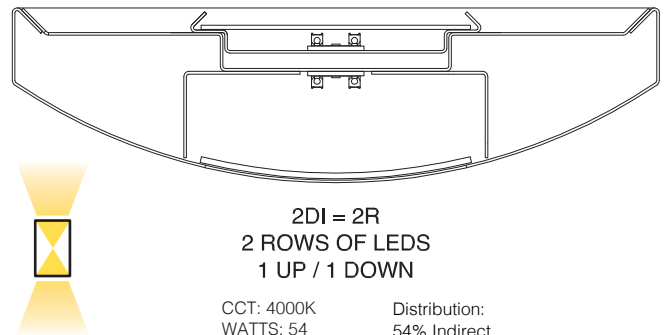

2DI = 2R
2 ROWS OF LEDS
1 UP / 1 DOWN

CCT: 4000K Distribution:
WATTS: 54 54% Indirect
LUMENS: 6860 46% Direct
LPW: 127

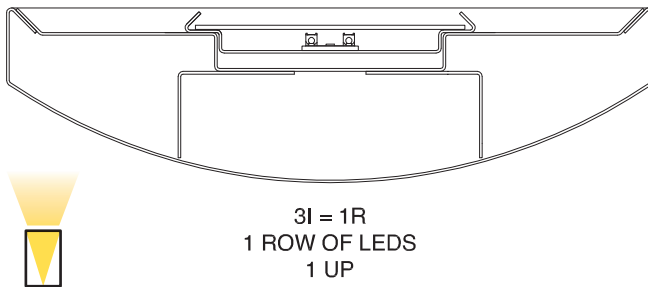

3I = 1R
1 ROW OF LEDS
1 UP

CCT: 4000K Distribution:
WATTS: 27 100% Indirect
LUMENS: 3689 0% Direct
LPW: 137

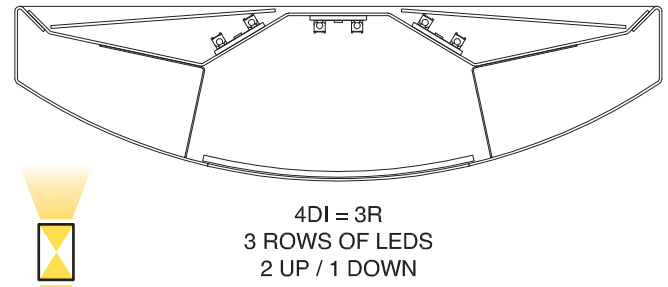

4DI = 3R
3 ROWS OF LEDS
2 UP / 1 DOWN

CCT: 4000K Distribution:
WATTS: 81 72% Indirect
LUMENS: 10,532 28% Direct
LPW: 130

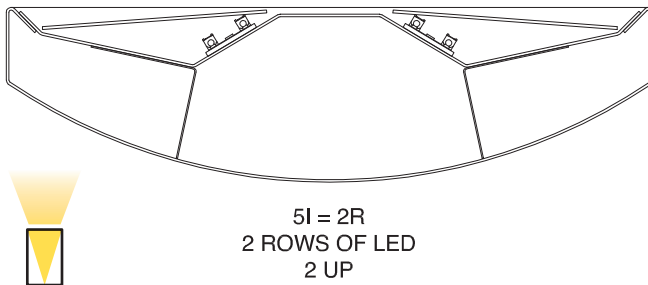

5I = 2R
2 ROWS OF LED
2 UP

CCT: 4000K Distribution:
WATTS: 54 100% Indirect
LUMENS: 7568 0% Direct
LPW: 140

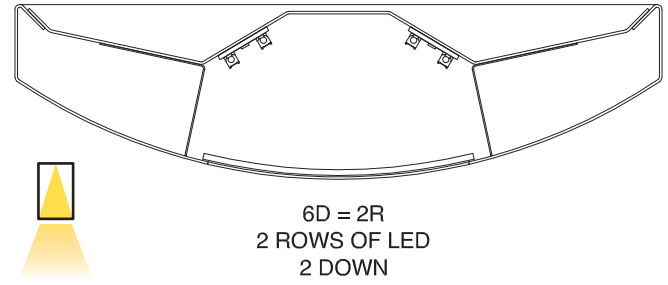

6D = 2R
2 ROWS OF LED
2 DOWN

CCT: 4000K Distribution:
WATTS: 54 0% Indirect
LUMENS: 5612 100% Direct
LPW: 104

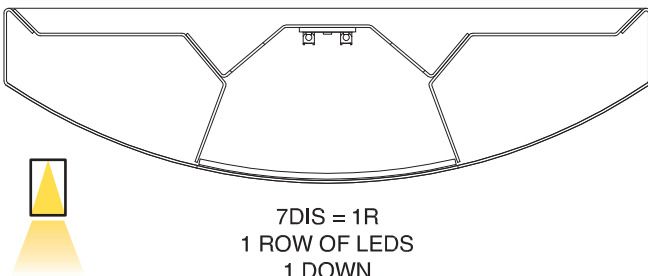

7DIS = 1R
1 ROW OF LEDS
1 DOWN

CCT: 4000K Distribution:
WATTS: 27 21% Indirect
LUMENS: 3362 79% Direct
LPW: 125

NOTES

- 1) Performance shown at 4000K CCT for 4' fixture.
- 2) Standard Output (SO) shown above.
- 3) See STYSL @ www.dayolite.com for all IES files.

Use the following multipliers for other CCTs: 2700K x 0.94, 3000K x 0.96, 3500K x 0.98, 5000K x 1.02. IES files @ www.dayolite.com

Standard Suspensions

Standard suspension options include adjustable self-locking aircraft cables (AC) and rigid pendant stems (PD). AC assembly is 48" x 1/16" with a 5" feed canopy and 2" suspension canopies. 60" 18 gauge power and 22 gauge dimming control SJT feed.

PD assemblies are 5/8" dia. (or 3/8" IP) hollow stem for power feed by others, 24" is standard. Consult factory for longer suspension lengths and other mounting options.

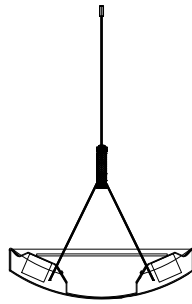

ACY = Aircraft Cable

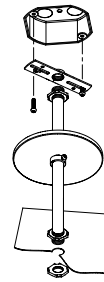

PD = Pendant Stem

Specifications

HOUSING: One-piece, die-formed, 20-gauge, cold rolled steel welded construction forming a 2 1/4" x 9" curved profile. Finished end caps are laser cut cold rolled steel.

REFLECTOR: Highly reflective, die-formed steel finished in baked white enamel is standard. Consult factory for high efficiency options.

OPTICS: White opal acrylic overlay direct, clear acrylic dust covers indirect.

LED: Static white LED modules in 27/30/35/40 & 50K CCT, 80/90CRI. Lumen maintenance minimum L_{70} = 50,000 hours. 3 SDCM color consistency. BIOS SkyBlue, RGB, RGBW and Tunable White and options available.

DRIVER: Standard driver is Class 2 AOC 0-10V to 1%, 120/277V input, PF > 90%, THD < 20 @ 120V. Additional dimming protocols available. All drivers prewired from factory for connection to control system (by others). Field replaceable.

MOUNTING: Standard options include adjustable self-locking aircraft cables (AC), and rigid pendant stems (PD). AC assembly is 48" x 1/16" with a 5" feed canopy and 2" suspension canopies. 18 gauge power and 22 gauge dimming control SJT feed.

FINISH: Fixture housing and steel components are finished in baked white enamel applied over a five-stage pretreatment process. Canopies and pendant stems are white enamel unless otherwise specified.

CERTIFICATION: cETLus listed conforming to UL STD. 1598 and certified to CSA STD C22.2 NO. 250.0. Suitable for dry & damp locations. Union Made in the United States of America, I.B.E.W, BAA compliant, Declare Red List Approved.

LEGAL: Day-O-Lite, a division of SCW Corporation. All rights reserved. The Day-O-Lite logo is a registered trademark of SCW Corporation. Day-O-Lite reserves the right to change specifications without notice for product improvement.