



DAY-O-LITE

Profile Series | PRFL-14-D-G

Date		Notes
Project		
Type	Qty	

Features

- Durable extruded aluminum housing.
- LED optimized optics for smooth, efficient illumination.
- Individual fixtures, continuous rows or custom patterns.
- Programmable driver for custom lumen packages.
- 0-10V dimming to 1% standard. Dim-to-off available.
- DMX, Lutron and DALI protocols also available.
- Sensor Ready for wireless Smart Lighting Solutions.
- 80/90CRI, Tunable White, RGBW & RGBWW.
- Bios SkyBlue™ circadian solutions available.

Declare Red List Approved.

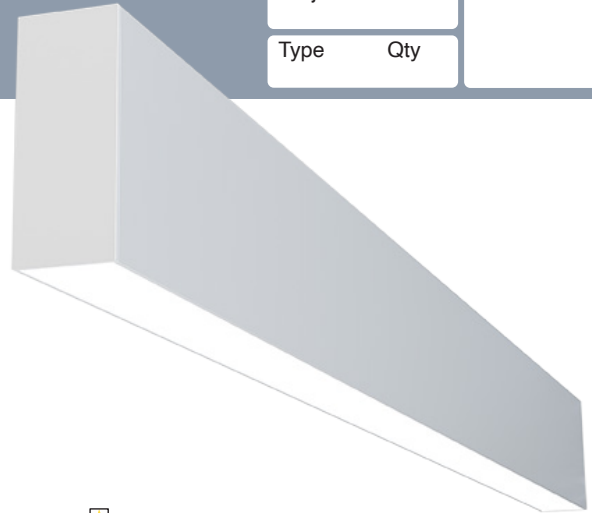
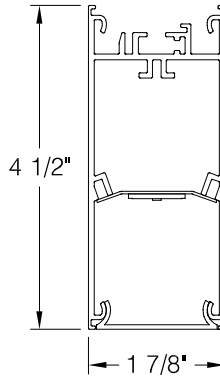

Ordering Guide



MODEL	OPTICS	LED ¹	LUMENS ²	LENGTH	MOUNTING ³	FINISH	OPTIONS ⁴
PRFL-14-D	SI						
PRFL-14-D Direct	STANDARD FL = Flush Opal Acrylic (snap-in) OPTIONAL GL = 1/4" Glow Lens CO = Continuous (to 50' max)	STATIC WHITE 27 = 2700K 30 = 3000K 35 = 3500K 40 = 4000K 50 = 5000K BIOS SkyBlue Spectrally optimized circadian solutions. TUNABLE WHITE (2700K-6500K) 2DIM10 = for 0-10V 2DMX = for DMX 2ESN = for Philips 2CAS = for Casambi- 2LUT = for Lutron DIM-TO-WARM (2700K-6500K) DTW = Dim-to-Warm RGB + WHITE RGB = RGB RGBW = RGBW RGBWW = RGBWW	LO = 435/ft (5W/ft, 87LPW) SO = 580/ft (7W/ft, 87LPW) HO = 725/ft (8W/ft, 87LPW) CUSTOM Specify lumen value < HO.	2 = 2 ft 3 = 3 ft 4 = 4 ft 5 = 5 ft 6 = 6 ft 7 = 7 ft 8 = 8 ft For other enter row length (48 =48 ft)	G = Grid 15/16" T-Bar MG = Mini Grid 9/16" T-Bar SG = Slot Grid SGF = Slot Grid Flush XG = Interlude XGF = Interlude Flush TGF = Tegular Flush 15/16" T-Bar XGF = Tegular Flush 9/16" T-Bar	W = White CC = Custom Color AMW = Anti-Microbial White	DIMMING DRIVERS DIM10 = 0-10V (1%) Standard DTO = 0-10V (Dim-to-Off) DIMST = 0-10V Step Dimming DIMSR = DALI Sensor Ready (5.0%) DALI = DALI (5.0%) DMX = DMX LUTRON™ DIMMING DRIVERS LDE1 = Hi-Lume 1% EcoSystem LD2 = Digital 1% (DALI-2) L3DA3W = Hi-Lume 1% 3-Wire SENSORS & CONTROLS⁴ AVO = Avi-On Sensor AWNS = Lutron Athena Sensor ESN = EasySense Sensor CAS = Casambi Wireless Control EMERGENCY⁵ EMC = Emergency Circuit GTD = Generator Transfer Device EPC4 = 4W Emergency Battery EPC6 = 6.5W Emergency Battery EPC10 = 10W Emergency Battery EPC12 = 12W Emergency Battery WIRING FWH = Flexible Wiring Harness DWH = DMX Wiring Harness

¹All LED, BIOS, Tunable White, DTW, and RGB/W options and Ordering Codes page 2.

²Lumens at 80CRI, 3500K, FL lens. Photometry page 5.

³See page 5 for mounting option details.

⁴All Sensor & Control options page 2.

⁵EPC6 is standard unless otherwise specified. EPC not for DMX drivers.

BAA letter of compliance available at www.dayolite.com.

LED, BIOS, Sensor & Control Ordering Codes

LED

Static White

30 = 3000K 80 CRI
 35 = 3500K 80 CRI
 40 = 4000K 80 CRI
 50 = 5000K 80 CRI

927 = 2700K 90 CRI
 930 = 3000K 90 CRI
 935 = 3500K 90 CRI
 940 = 4000K 90 CRI

Tunable White¹
(2700K-6500K)

2DIM10 = 0-10V 80 CRI
 2DMX = DMX 80 CRI
 2CAS = Casambi Wireless 80 CRI
 2ESN = Philips EasySense 80 CRI
 2LUT = Lutron (LD2) 80 CRI

92DIM10 = 0-10V 90 CRI
 92DMX = DMX 90 CRI
 92CAS = Casambi Wireless 90 CRI
 92ESN = Philips EasySense 90 CRI
 92LUT = Lutron (LD2) 90 CRI

Dim-to-Warm²

DTW = 6500K-2700K 80 CRI
 9DTW = 6500K-2700K 90 CRI

RGB/W³

RGB = RGB only
 RGB27 = RGB w/2700K
 RGB30 = RGB w/3000K
 RGB35 = RGB W/3500K
 RGB40 = RGB w/4000K
 RGB50 = RGB w/5000K
 RGBWW = RGB w/2700K-6500K

Single Color⁴

RED = Red
 BLU = Blue
 GRN = Green
 AMB = Amber

BIOS SkyBlue



BIOS Biological Static

For daytime applications. BIOS Static Biological LED features key BIOS SkyBlue (490nm) for maximum daytime circadian impact.

B30 = 3000K
 B35 = 3500K
 B40 = 4000K

BIOS Biological Dynamic White

Designed to transition from daytime to evening in a dim-to-warm protocol. The daytime CCT includes full BIOS SkyBlue (490nm) for maximum daytime circadian impact, while the evening spectrum removes BIOS SkyBlue for minimal circadian stimulus after hours.

B30D = 3000K-2700K
 B35D = 3500K-3000K
 B40D = 4000K-3500K

BIOS Biological Tunable White

Designed to transition from daytime to evening in a tunable white protocol. The daytime CCT includes full BIOS SkyBlue (490nm) for maximum daytime circadian impact, while the evening spectrum removes BIOS SkyBlue for minimal circadian stimulus after hours.

B30T = 3000K-2700K
 B35T = 3500K-2700K
 B40T = 4000K-2700K

Sensors & Controls

Sensors*

AVO = Avi-On Occ/Day
 AVM = Avi-On Occ (Microwave)
 BNV = BubblyNet Occ/Day
 ENC = Encelium Occ/Day
 ENL = EnLighted Occ/Day/Temp
 LEG = Legrand Occ/Day
 ANW = Lutron Athena Occ/Day
 VIVE = Lutron Vive Occ/Day
 NLT = Acuity nLight Occ/Day
 NXC = Current NX Occ/Day
 ESN = Philips EasySense Occ/Day
 WWL = Cooper WaveLinX Occ/Day

Wireless Control

CAS = Casambi

*Some options may not be fixture integral. Contact factory for details.

Sensors and control options to be commissioned wirelessly in the field by qualified controls personnel with applicable apps (by others).

Other Options

Other sensor and wireless control options are available. Contact factory for details.

¹Tunable white may be controlled by a number of dimming protocols as shown.

²Dim-to-Warm mimics incandescent dimming by warming the CCT from 6500K to 2700K as light levels are dimmed.

³All RGB, RGBW and RGBWW options for DMX control (by others). 80 CRI standard.

⁴Single colors are constant voltage LEDs. Dimming requires ELV controller (by others).

Individual Fixtures & Continuous Rows

NOMINAL LENGTH	GRID O.C.
2'	2'
4'	4'
8'	8'
12'	12'
16'	16'
20'	20'
24'	24'

Individual fixtures and rows are continuously illuminated and joined with included aligner brackets and hardware. Power feed locations and mounting locations are shown below. Continuous rows longer than 8' and patterns, including EPC/EMC and sensor locations must be approved prior to manufacturing.

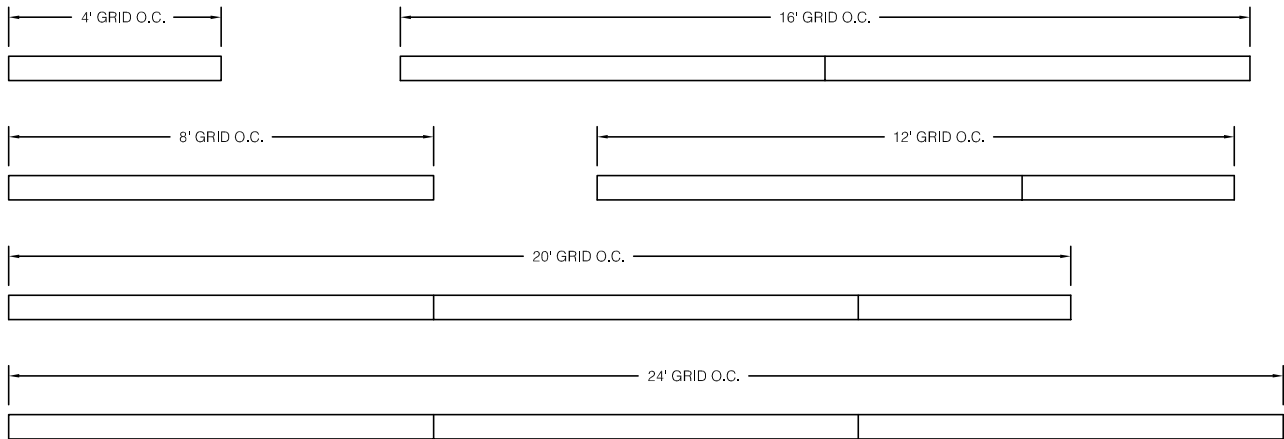

Emergency & Sensor Locations

EPC will control entire length of individual fixtures. Individual fixtures of differing lengths will deliver the same lumens under EPC power (a 4' fixture will deliver the same total lumens over half the length of an 8' fixture). **EMC** controlled individual fixtures will deliver lumens per foot as originally specified, unless dimmed at time of power loss. Consult factory for EMC dimming override device.

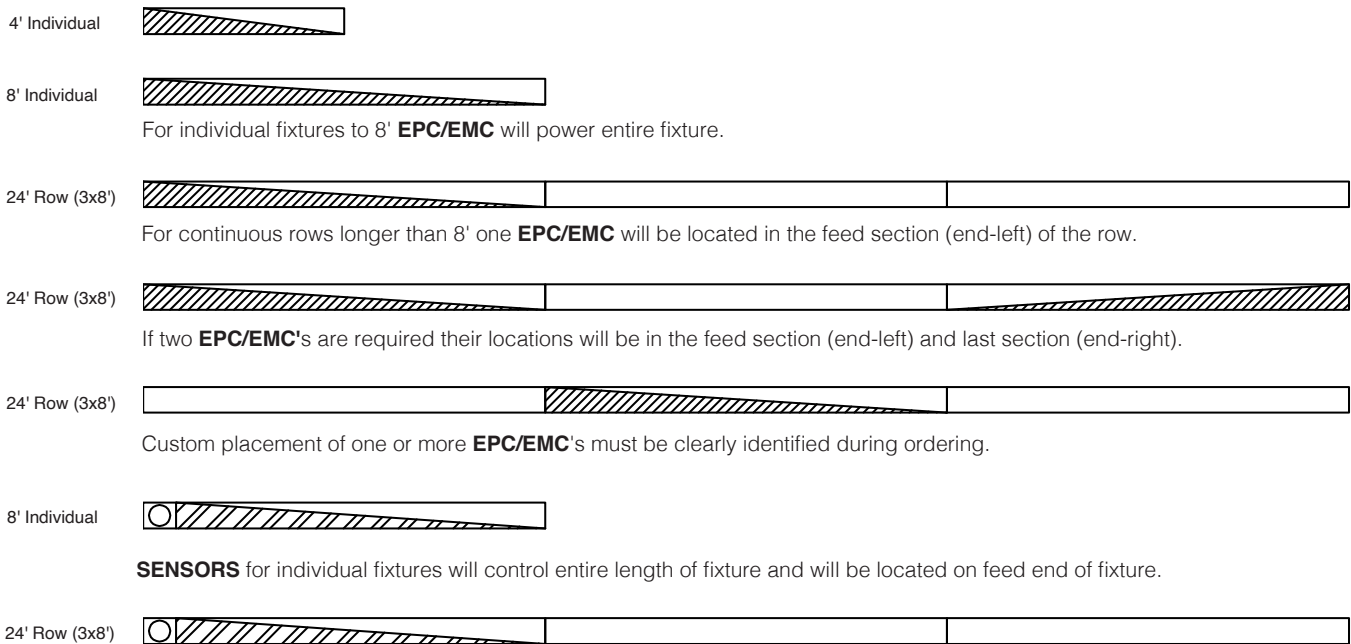

SENSORS for rows will control the feed section (end-left) of the row. Sensors can control more than an 8' section within a row. Consult factory for sensor/section options, or for multiple sensors in a continuous row.

Pattern Guide

Profile may be specified in patterns of virtually any configuration. All patterns and corners are continuously illuminated and joined with included aligner brackets and joining hardware. See examples below for suggestions with actual and nominal dimensions. Day-O-Lite's custom manufacturing capabilities allow the specification of custom angled connectors to make non-square patterns possible. (See ILX example below).

All corners and connectors are fully welded to ensure correct dimensions and "square" joinery when assembled.

How to Specify

- 1. Submit your pattern to Day-O-Lite in dimensioned CAD file or submit a fully dimensioned PDF file.
- 2. If EPC/EMC or Sensors are to be included their location needs to be clearly noted.
- 3. Day-O-Lite will design your pattern to as close as is nominally possible given standard LED module lengths, including connectors.
- 4. Day-O-Lite will supply a detailed drawing for approval with final dimensions. All patterns must be approved prior to manufacture.

Pattern Examples

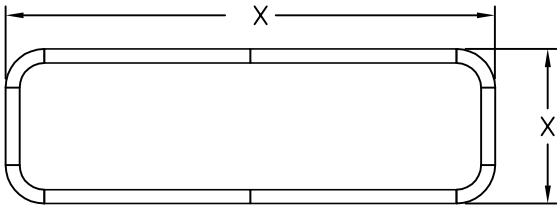
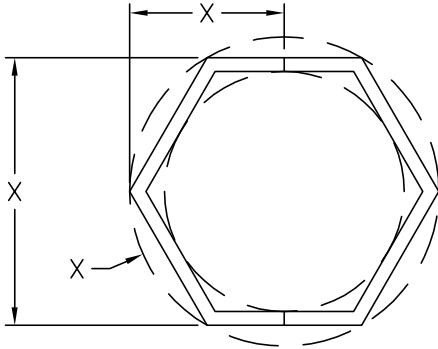
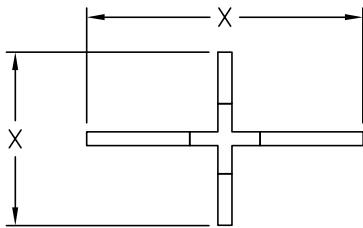
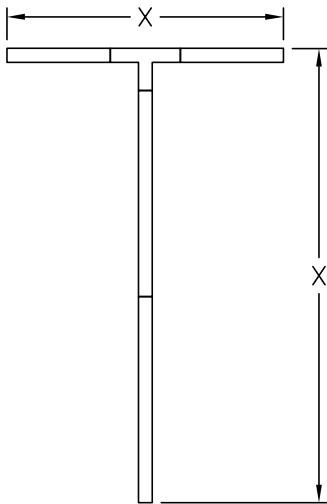
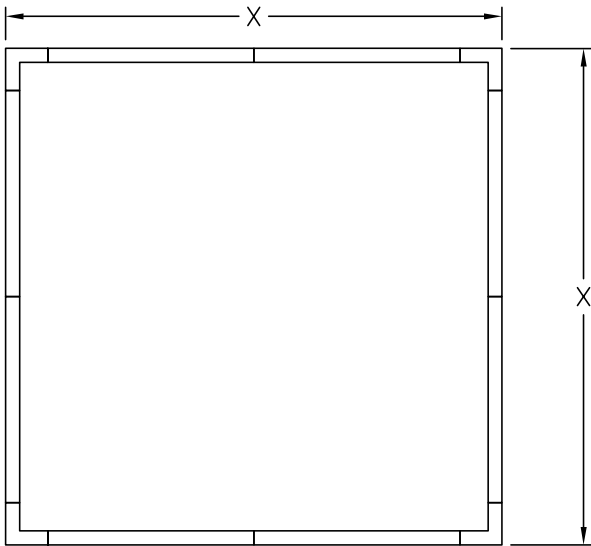

Illuminated Connectors

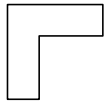

ILC2 = 90° Corner

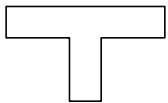

ILC3 = 90° Tee

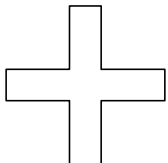

ILC4 = 90° Cross

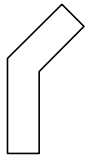

ILCX = X° Custom



ILCR = Custom Radius

Mounting Options

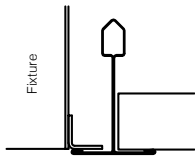

G
15/16" T-Bar

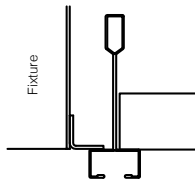

MG
9/16" T-Bar

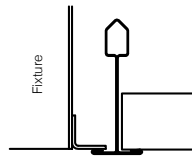

SG
Slot Grid

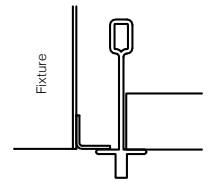

XG
Interlude

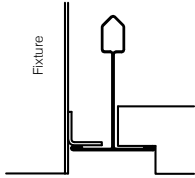

TGF
15/16" Tegular
Flush

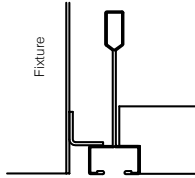

MTGF
9/16" Tegular
Flush

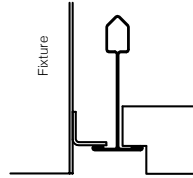

SGF
Slot Grid
Flush

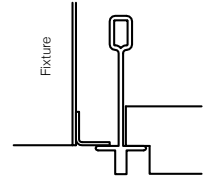

XGF
Interlude
Flush

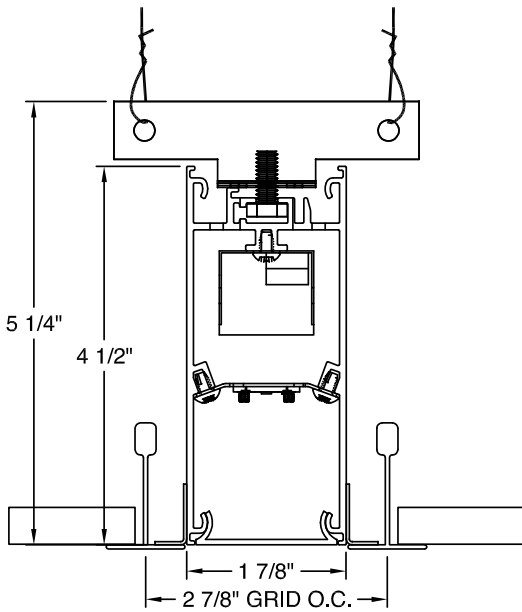

Photometry

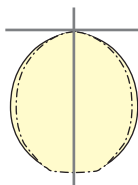

PRFL-14-D-FL-35-**LO**-4

3500K CCT
WATTS: 20
LUMENS: 1739
LPW: 87

PRFL-14-D-FL-35-**SO**-4

3500K CCT
WATTS: 27
LUMENS: 2319
LPW: 87

PRFL-14-D-FL-35-**HO**-4

3500K CCT
WATTS: 33
LUMENS: 2899
LPW: 87

3500K @ 80CRI, 4', FL lens.

Use the following multipliers for other CCTs: 2700K x 0.96, 3000K x 0.98, 4000K x 1.02, 5000K x 1.03. IES files @ www.dayolite.com

Specifications

CONSTRUCTION: Extruded aluminum side housing. 20 gauge cold rolled steel top and internal components.

REFLECTOR: Highly reflective baked white enamel with pre-finished reflective LED tray.

OPTICS: Options include opal acrylic Flush lens, 1/4" Glow and Continuous Lenses (to 50').

LED: Static white LED modules in 30/35/40 & 50K CCT, 80/90CRI. Lumen maintenance minimum L_{70} = 50,000 hours. 3 SDCM color consistency. BIOS SkyBlue, RGB, RGBW, RGBWW, Tunable White and Dim-to-Warm options available; field replaceable.

DRIVER: Standard driver is Class 2 AOC 0-10V to 1%, Dim-to-Off available. 120/277V input, PF > 90%, THD < 20 @ 120V. DMX, DALI & Lutron protocols available. All drivers prewired for connection to control system (by others); field replaceable.

MOUNTING: Standard mounting is in suspended grid ceilings.

FINISH: Housing and components finished in baked white enamel.

CERTIFICATION: cETLus listed conforming to UL STD. 1598 and certified to CSA STD C22.2 NO. 250.0. Suitable for dry & damp locations. Union Made in the United States of America, I.B.E.W, BAA compliant, Declare Red List Approved.

LEGAL: Day-O-Lite, a division of SCW Corporation. All rights reserved. The Day-O-Lite logo is a registered trademark of SCW Corporation. Day-O-Lite reserves the right to change specifications without notice for product improvement.