

Date		Notes
Project		
Type	Qty	

Features

- Durable steel housing w/welded end-plates.
- LED optimized optics in multiple configurations.
- LED optimized optics for smooth, efficient illumination.
- Programmable driver for custom lumen packages.
- 0-10V dimming to 1% standard or Dim-to-Off.
- DMX, Lutron and DALI protocols also available.
- Sensor Ready for wireless Smart Lighting Solutions.
- 80/90CRI, Tunable White, RGBW & RGBWW.
- Bios SkyBlue™ circadian solutions available.

Declare Red List Approved.

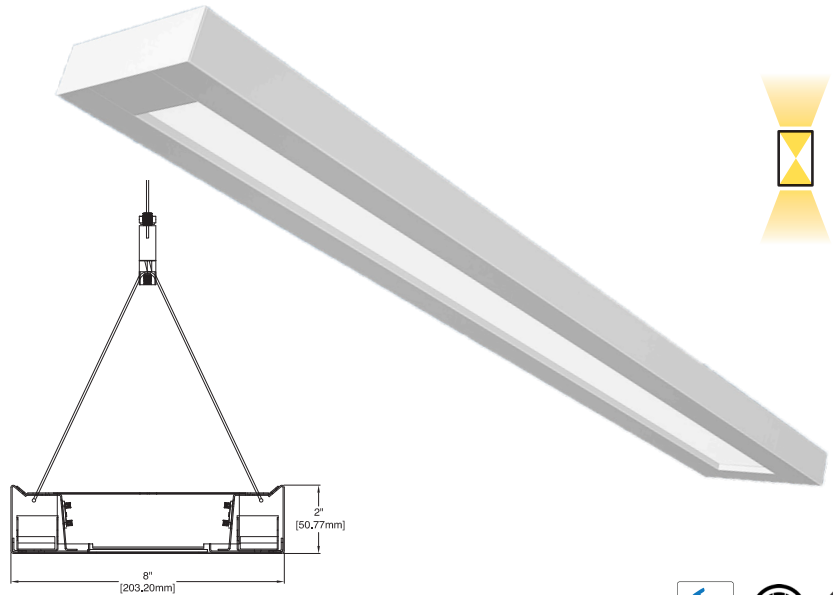

Ordering Guide



MODEL	OPTICS	CCT ¹	LUMENS ²	LENGTH	MOUNTING ³	FINISH	OPTIONS
ELTL-1-XX	SI						
ELTL-1-D 100% Direct ELTL-1-DI 80% Indirect 20% Direct	SI = Satin Ice Acrylic w/clear indirect acrylic dust cover	27 = 2700K 80CRI 30 = 3000K 80CRI 35 = 3500K 80CRI 40 = 4000K 80CRI 50 = 5000K 80CRI BIOS SkyBlue Spectrally optimized circadian solutions. TUNABLE WHITE (2700K-6500K) 2DIM10 = for 0-10V 2DMX = for DMX 2ESN = for Philips 2CAS = for Casambi 2LUT = for Lutron DIM-TO-WARM (2700K-6500K) DTW = Dim-to-Warm RGB + WHITE RGB = RGB RGBW = RGBW RGBWW = RGBWW	DIRECT LO = 813/ft (10W/ft, 81LPW) SO = 1082/ft Direct (14W/ft, 80LPW) HO = 1352/ft Direct (18W/ft, 77LPW) DIRECT/INDIRECT LO = 800/ft Indirect 580/ft Direct (10W/ft, 138LPW) SO = 1065/ft Indirect 772/ft Direct (14W/ft, 136LPW) HO = 1325/ft Indirect 960/ft Direct (18W/ft, 130LPW) CUSTOM For custom lumens specify value < HO.	4 = 4 ft 6 = 6 ft 8 = 8 ft For other enter row length (e.g. 48 = 48 ft)	ACY = Aircraft Cable (Y) PD = Pendant	W = White CC = Custom Color AMW = Anti-Microbial White	DIMMING DRIVERS DIM10 = 0-10V (1%) Standard DTO = 0-10V (Dim-to-Off) DIMST = 0-10V Step Dimming DIMSR = DALI Sensor Ready (5.0%) DALI = DALI (5.0%) DMX = DMX LUTRON™ DIMMING DRIVERS LDE1 = Hi-Lume 1% EcoSystem LD2 = Digital 1% (DALI-2) L3DA3W = Hi-Lume 1% 3-Wire SENSORS & CONTROLS⁴ AVO = Avi-On Sensor AWNS = Lutron Athena Sensor ESN = EasySense Sensor CAS = Casambi Wireless Control EMERGENCY⁵ EMC = Emergency Circuit GTD = Generator Transfer Device EPC4 = 4W Emergency Battery EPC6 = 6.5W Emergency Battery EPC10 = 10W Emergency Battery EPC12 = 12W Emergency Battery WIRING TCW = Two Circuit Wiring FWH = Flexible Wiring Harness DWH = DMX Wiring Harness

¹All LED, BIOS, Tunable White, DTW, and RGB/W options and Ordering Codes page 2.
²Lumens at 80CRI, 4000K, SI/CA lens. Photometry page 4.
³See page 4 for mounting option details.
⁴All Sensor & Control options page 2.
⁵EPC6 is standard unless otherwise specified. EPC not for DMX drivers.

BAA letter of compliance available at www.dayolite.com.

RS 10 Day Rapid Ship options in **blue**. Details page 4.

LED, BIOS, Sensor & Control Ordering Codes

LED

Static White

30 = 3000K 80 CRI
 35 = 3500K 80 CRI
 40 = 4000K 80 CRI
 50 = 5000K 80 CRI

927 = 2700K 90 CRI
 930 = 3000K 90 CRI
 935 = 3500K 90 CRI
 940 = 4000K 90 CRI

Tunable White¹
(2700K-6500K)

2DIM10 = 0-10V 80 CRI
 2DMX = DMX 80 CRI
 2CAS = Casambi Wireless 80 CRI
 2ESN = Philips EasySense 80 CRI
 2LUT = Lutron (LD2) 80 CRI

92DIM10 = 0-10V 90 CRI
 92DMX = DMX 90 CRI
 92CAS = Casambi Wireless 90 CRI
 92ESN = Philips EasySense 90 CRI
 92LUT = Lutron (LD2) 90 CRI

Dim-to-Warm²

DTW = 6500K-2700K 80 CRI
 9DTW = 5000K-3000K 90 CRI

RGB/W³

(80 CRI, Consult factory for 90 CRI)

RGB = RGB only
 RGB27 = RGB w/2700K
 RGB30 = RGB w/3000K
 RGB35 = RGB W/3500K
 RGB40 = RGB w/4000K
 RGB50 = RGB w/5000K
 RGBWW = RGB w/2700K-6500K

Single Color⁴

RED = Red
 BLU = Blue
 GRN = Green
 AMB = Amber

BIOS SkyBlue



BIOS SkyBlue biological technology brings the benefits of blue skies inside. BIOS SkyBlue is the only spectrally optimized circadian solution to pinpoint the region that drives wellness benefits including: increased alertness, enhanced productivity, better mood, and better sleep. More information may be found at www.bioslighting.com or by contacting Day-O-Lite directly. All options for 0-10V control.

BIOS Biological Static

For daytime applications. BIOS Static Biological LED features key BIOS SkyBlue (490nm) for maximum daytime circadian impact.

B30 = 3000K
B35 = 3500K
B40 = 4000K

BIOS Biological Dynamic White

Designed to transition from daytime to evening in a dim-to-warm protocol. The daytime CCT includes full BIOS SkyBlue (490nm) for maximum daytime circadian impact, while the evening spectrum removes BIOS SkyBlue for a minimal circadian stimulus after hours.

B30D = 3000K-2700K
B35D = 3500K-3000K
B40D = 4000K-3500K

BIOS Biological Tunable White

Designed to transition from daytime to evening in a tunable white protocol. The daytime CCT includes full BIOS SkyBlue (490nm) for maximum daytime circadian impact, while the evening spectrum removes BIOS SkyBlue for a minimal circadian stimulus after hours.

B30T = 3000K-2700K
B35T = 3500K-2700K
B40T = 4000K-2700K

Sensors & Controls

Sensors

AVO = Avi-On Occ/Day
 AVM = Avi-On Occ (Microwave)
 BNV = BubblyNet Occ/Day
 ENC = Encelium Occ/Day
 ENL = EnLighted Occ/Day/Temp
 LEG = Legrand Occ/Day
 ANW = Lutron Athena Occ/Day
 VIVE = Lutron Vive Occ/Day
 NLT = Acuity nLight Occ/Day
 NXC = Current NX Occ/Day
 ESN = Philips EasySense Occ/Day
 WVW = Cooper WaveLinx Occ/Day

Wireless Control

CAS = Casambi

Sensors and control options to be commissioned wirelessly in the field by qualified controls personnel with applicable apps (by others).

Other Options

Other sensor and wireless control options are available. Contact factory for details.

¹Tunable white may be controlled by a number of dimming protocols as shown.

²Dim-to-Warm mimics incandescent dimming by warming the CCT from 6500K to 2700K as light levels are dimmed.

³All RGB, RGBW and RGBWW options for DMX control (by others).

⁴Single colors are constant voltage LEDs. Dimming requires ELV controller (by others).

Individual Fixtures & Continuous Rows

NOMINAL LENGTH	ACTUAL LENGTH	SUSP. 1 O.C.	SUSP. 2 O.C.	SUSP. 3 O.C.
4'	4' 1/8"	3' 10"		
8'	8' 1/8"	7' 10"		
12'	12' 1/8"	7' 10"	4'	
16'	16' 1/8"	7' 10"	8'	
20'	20' 1/8"	7' 10"	8'	4'
24'	24' 1/8"	7' 10"	8'	8'

Individual fixtures up to 8' nominal and continuous rows up to 24' nominal and suspension centers are dimensioned as shown below. Continuous rows longer than 8' and patterns including EPC/EMC and sensor locations must be approved prior to manufacturing.

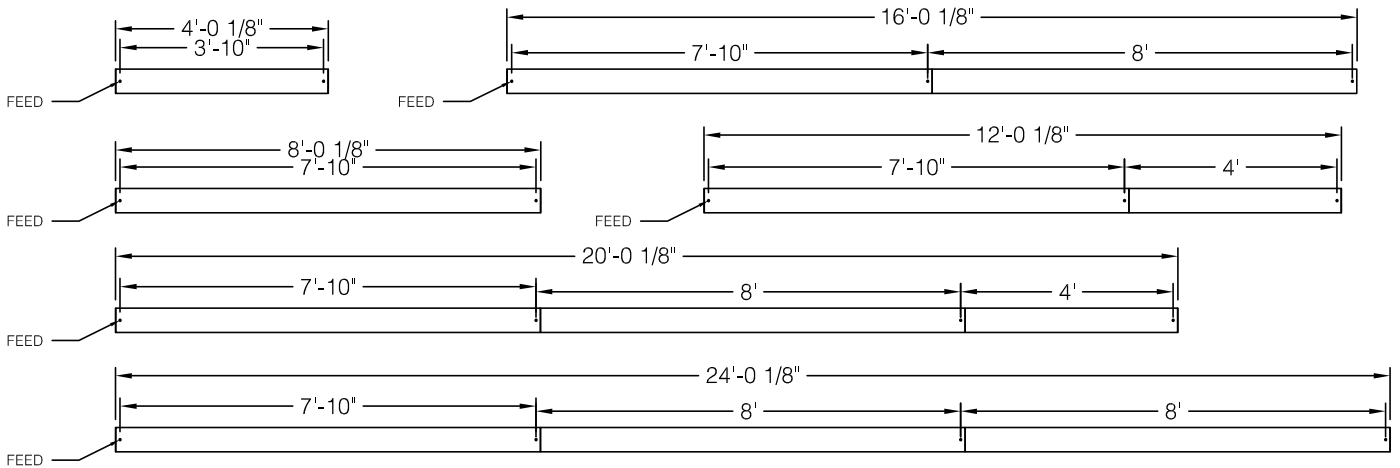

Emergency & Sensor Locations

EPC will control entire length of individual fixtures. Individual fixtures of differing lengths will deliver the same lumens under EPC power (a 4' fixture will deliver the same total lumens over half the length of an 8' fixture). EMC controlled individual fixtures will deliver lumens per foot as originally specified, unless dimmed at time of power loss. Consult factory for EMC dimming override device.



For individual fixtures to 8' EPC/EMC will power entire fixture.

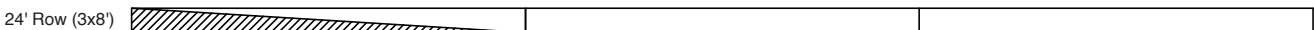

For continuous rows longer than 8' one EPC/EMC will be located in the feed section (end-left) of the row as shown below.

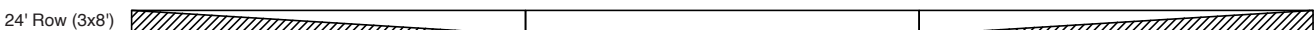

If two EPC/EMC's are required their default locations will be in the feed section (end-left) and last section (end-right) as below.



Custom placement of one or more EPC/EMC's must be clearly identified during ordering.



SENSORS (Integral) for individual fixtures will control entire length of fixture and will be located on feed end of fixture.

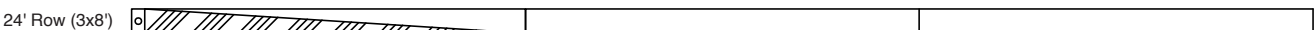

SENSORS for rows by default will control the feed section (end-left) of the row. Sensors can control more than an 8' section within a row. Consult factory for sensor/section options, or for multiple sensors in a continuous row.

Standard Suspensions

Standard suspension options include adjustable self-locking aircraft cables (AC) and rigid pendant stems (PD). AC assembly is 48" x 1/16" with a 5" feed canopy and 2" suspension canopies. 60" 18 gauge power and 22 gauge dimming control SJT feed.

PD assemblies are 5/8" dia. (or 3/8" IP) hollow stem for power feed by others, 24" is standard. Consult factory for longer suspension lengths and other mounting options.

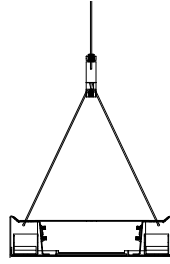

ACY = Aircraft Cable

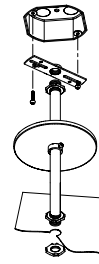

PD = Pendant Stem

Photometry

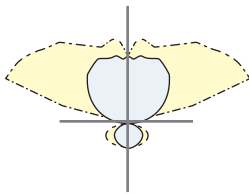

ELTL-1-DI-SI-40-**LO**-4 CCT

4000K
WATTS: 40
LUMENS: 5511
LPW: 138
Distribution:
58% Indirect
42% Direct

ELTL-1-DI-SI-40-**SO**-4 CCT

4000K
WATTS: 54
LUMENS: 7348
LPW: 136
Distribution:
58% Indirect
42% Direct

ELTL-1-DI-SI-40-**HO**-4 CCT

4000K
WATTS: 70
LUMENS: 9134
LPW: 130
Distribution:
58% Indirect
42% Direct

40000K @ 80CRI, SI lens w/CA dust covers.

Use the following multipliers for other CCTs: 2700K x 0.94, 3000K x 0.96, 3500K x 0.98, 5000K x 1.02. IES files @ www.dayolite.com

Specifications

CONSTRUCTION: Die-formed, 20-gauge, cold rolled steel.

REFLECTOR: Highly reflective, die-formed steel finished in baked white enamel is standard. Consult factory for high efficiency options.

OPTICS: Standard shielding is LED optimized Satin Ice Acrylic.

LED: Static white LED modules in 27/30/35/40 & 50K CCT, 80/90CRI. Lumen maintenance minimum L_{70} = 50,000 hours. 3 SDCM color consistency. BIOS SkyBlue, RGB, RGBW, RGBWW. Tunable White and Dim-to-Warm options available.

DRIVER: Standard driver is Class 2 AOC 0-10V to 1%, Dim-to-Off available. 120/277V input, PF > 90%, THD < 20 @ 120V. Additional dimming protocols available. All drivers prewired from factory for connection to control system (by others), field replaceable.

MOUNTING: Standard options include adjustable self-locking aircraft cables (AC), and rigid pendant stems (PD). AC assembly is 48" x 1/16" with a 5" feed canopy and 2" suspension canopies. 18 gauge power and 22 gauge dimming control SJT feed.

FINISH: Fixture housing and steel components are finished in baked white enamel applied over a five-stage pretreatment process. Canopies and pendant stems are white enamel unless otherwise specified.

CERTIFICATION: Luminaires are cETLus listed conforming to UL STD. 1598 and certified to CSA STD C22.2 NO. 250.0. Suitable for dry & damp locations. Union Made in the United States of America. I.B.E.W., BAA compliant, Declare Red List Approved.

LEGAL: Day-O-Lite, a division of SCW Corporation. All rights reserved. The Day-O-Lite logo is a registered trademark of SCW Corporation. Day-O-Lite reserves the right to change specifications without notice for product improvement.

RS Rapid Ship Program

Rapid Ship products are estimated to ship 10 business days or less from the morning the order is received and confirmed. Linear rows will ship 10 business days or less from the day the layout drawings are approved. Orders confirmed and layouts approved after 12:00 p.m. Eastern Time are estimated to ship 10 days or less from the following business morning. Please refer to complete program Terms & Conditions at www.dayolite.com.

Rapid Ship options are limited to those highlighted in **blue** on the Ordering Guide. 400' max individual or continuous row allowed. Consult factory for additional information.