



# Profile Series | PRFL-44W-D-F/TRL

Date	Notes
Project	
Type Qty	

## Features

- Durable extruded aluminum housing.
- LED optimized optics for smooth, efficient illumination.
- Individual fixtures, continuous rows or custom patterns.
- Programmable driver for custom lumen packages.
- 0-10V dimming to 1% standard. Dim-to-off available.
- DMX, Lutron and DALI protocols also available.
- Sensor Ready for wireless Smart Lighting Solutions.
- 80/90CRI, Tunable White, RGBW & RGBWW.
- Bios SkyBlue™ circadian solutions available.

**Declare Red List Approved.**

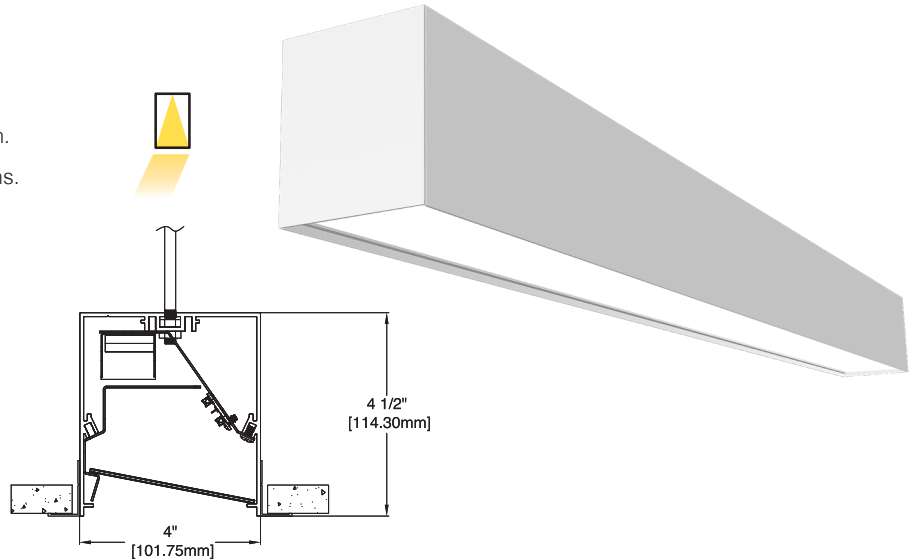

## Ordering Guide



MODEL	OPTICS	LED <sup>1</sup>	LUMENS <sup>2</sup>	SIZE	MOUNTING <sup>3</sup>	FINISH	OPTIONS
<b>PRFL-44W-D</b>							
PRFL-44W-D Direct Wall Wash	SI = Satin Ice Acrylic (lay-in)  AS* = Asymmetric Clear Acrylic Lens (lay-in)  *AS lens will not fully hide LEDs.	<b>STATIC WHITE</b> 27 = 2700K 30 = 3000K 35 = 3500K 40 = 4000K 50 = 5000K  <b>BIOS SkyBlue</b> Spectrally optimized circadian solutions.  <b>TUNABLE WHITE</b> (2700K-6500K) 2DIM10 = for 0-10V 2DMX = for DMX 2ESN = for Philips 2CAS = for Casambi- 2LUT = for Lutron  <b>DIM-TO-WARM</b> (2700K-6500K) DTW = Dim-to-Warm  <b>RGB + WHITE</b> RGB = RGB RGBW = RGBW RGBWW = RGBWW	<b>STANDARD</b> LO = 510/ft (5W/ft, 105LPW)  SO = 690/ft (7W/ft, 103LPW) HO = 860/ft (9W/ft, 100LPW)  <b>CUSTOM</b> Specify lumen value < HO.	2 = 2 ft 3 = 3 ft 4 = 4 ft 5 = 5 ft 6 = 6 ft 7 = 7 ft 8 = 8 ft  For other enter row length (e.g. 48 = 48 ft)	F = Flanged  TRL = Trimless	W = White  CC = Custom Color  AMW = Anti-Microbial White	<b>DIMMING DRIVERS</b> DIM10 = 0-10V (1%) Standard DTO = 0-10V (Dim-to-Off) DIMST = 0-10V Step Dimming DIMSR = DALI Sensor Ready (5.0%) DALI = DALI (5.0%) DMX = DMX  <b>LUTRON™ DIMMING DRIVERS</b> LDE1 = Hi-Lume 1% EcoSystem LD2 = Digital 1% (DALI-2) L3DA3W = Hi-Lume 1% 3-Wire  <b>SENSORS &amp; CONTROLS<sup>4</sup></b> AVO = Avi-On Sensor AWNS = Lutron Athena Sensor ESN = EasySense Sensor CAS = Casambi Wireless Control  <b>EMERGENCY<sup>5</sup></b> EMC = Emergency Circuit GTD = Generator Transfer Device EPC4 = 4W Emergency Battery EPC6 = 6.5W Emergency Battery EPC10 = 10W Emergency Battery EPC12 = 12W Emergency Battery  <b>WIRING</b> FWH = Flexible Wiring Harness DWH = DMX Wiring Harness

<sup>1</sup>All LED, BIOS, Tunable White, DTW, and RGB/W options and Ordering Codes page 2.

<sup>2</sup>Lumens at 80CRI, 4000K, SI lens. Photometry page 5.

<sup>3</sup>See page 5 for mounting option details.

<sup>4</sup>All Sensor & Control options page 2.

<sup>5</sup>EPC6 is standard unless otherwise specified. EPC not for DMX drivers.

**BAA** letter of compliance available at [www.dayolite.com](http://www.dayolite.com).

## LED, BIOS, Sensor & Control Ordering Codes

### LED

#### Static White

30 = 3000K 80 CRI  
 35 = 3500K 80 CRI  
 40 = 4000K 80 CRI  
 50 = 5000K 80 CRI

927 = 2700K 90 CRI  
 930 = 3000K 90 CRI  
 935 = 3500K 90 CRI  
 940 = 4000K 90 CRI

#### Tunable White<sup>1</sup> (2700K-6500K)

2DIM10 = 0-10V 80 CRI  
 2DMX = DMX 80 CRI  
 2CAS = Casambi Wireless 80 CRI  
 2ESN = Philips EasySense 80 CRI  
 2LUT = Lutron (LD2) 80 CRI

92DIM10 = 0-10V 90 CRI  
 92DMX = DMX 90 CRI  
 92CAS = Casambi Wireless 90 CRI  
 92ESN = Philips EasySense 90 CRI  
 92LUT = Lutron (LD2) 90 CRI

#### Dim-to-Warm<sup>2</sup>

DTW = 6500K-2700K 80 CRI  
 9DTW = 6500K-2700K 90 CRI

#### RGB/W<sup>3</sup>

RGB = RGB only  
 RGB27 = RGB w/2700K  
 RGB30 = RGB w/3000K  
 RGB35 = RGB W/3500K  
 RGB40 = RGB w/4000K  
 RGB50 = RGB w/5000K  
 RGBWW = RGB w/2700K-6500K

#### Single Color

RED = Red  
 BLU = Blue  
 GRN = Green  
 AMB = Amber

### BIOS SkyBlue



BIOS SkyBlue biological technology brings the benefits of blue skies inside. BIOS SkyBlue is the only spectrally optimized circadian solution to target the region that drives wellness benefits including: increased alertness, enhanced productivity, better mood, and better sleep. More information may be found at [www.bioslighting.com](http://www.bioslighting.com) or by contacting Day-O-Lite directly. All options for 0-10V control.

#### BIOS Biological Static

For daytime applications. BIOS Static Biological LED features key BIOS SkyBlue (490nm) for maximum daytime circadian impact.

B30 = 3000K  
 B35 = 3500K  
 B40 = 4000K

#### BIOS Biological Dynamic White

Designed to transition from daytime to evening in a dim-to-warm protocol. The daytime CCT includes full BIOS SkyBlue (490nm) for maximum daytime circadian impact, while the evening spectrum removes BIOS SkyBlue for minimal circadian stimulus after hours.

B30D = 3000K-2700K  
 B35D = 3500K-3000K  
 B40D = 4000K-3500K

#### BIOS Biological Tunable White

Designed to transition from daytime to evening in a tunable white protocol. The daytime CCT includes full BIOS SkyBlue (490nm) for maximum daytime circadian impact, while the evening spectrum removes BIOS SkyBlue for minimal circadian stimulus after hours.

B30T = 3000K-2700K  
 B35T = 3500K-2700K  
 B40T = 4000K-2700K

### Sensors & Controls

#### Sensors\*

AVO = Avi-On Occ/Day  
 AVM = Avi-On Occ (Microwave)  
 BNV = BubblyNet Occ/Day  
 ENC = Encelium Occ/Day  
 ENL = EnLighted Occ/Day/Temp  
 LEG = Legrand Occ/Day  
 ANW = Lutron Athena Occ/Day  
 VIVE = Lutron Vive Occ/Day  
 NLT = Acuity nLight Occ/Day  
 NXC = Current NX Occ/Day  
 ESN = Philips EasySense Occ/Day  
 WWL = Cooper WaveLinX Occ/Day

#### Wireless Control\*

CAS = Casambi

\*Sensors and control options to be commissioned wirelessly in the field by qualified controls personnel with applicable apps (by others).

#### Other Options

Other sensor and wireless control options are available. Contact factory for details.

<sup>1</sup>Tunable white may be controlled by a number of dimming protocols as shown.

<sup>2</sup>Dim-to-Warm mimics incandescent dimming by warming the CCT from 6500K to 2700K as light levels are dimmed.

<sup>3</sup>All RGB, RGBW and RGBWW options for DMX control (by others). 80 CRI standard.

### Individual Fixtures & Continuous Rows

NOMINAL LENGTH	ACTUAL LENGTH
4'	3' 8-1/2"
8'	7' 5"
12'	11' 1-1/2"
16'	14' 10"
20'	18' 6-1/2"
24'	22' 3"

Individual fixtures and rows are continuously illuminated and joined with included aligner brackets and hardware. Fixtures up to 8' nominal and continuous rows up to 24' nominal are dimensioned as shown below.

Continuous rows longer than 8' and patterns, including EPC/EMC and sensor locations must be approved prior to manufacturing. See following page for specifying patterns.

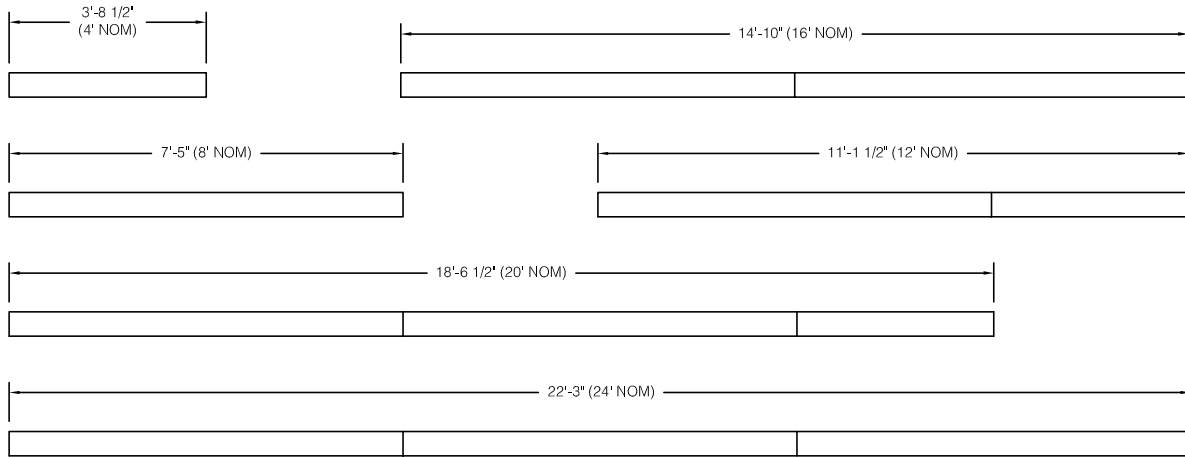

### Emergency & Sensor Locations

EPC will control entire length of individual fixtures. Individual fixtures of differing lengths will deliver the same lumens under EPC power (a 4' fixture will deliver the same total lumens over half the length of an 8' fixture). EMC controlled individual fixtures will deliver lumens per foot as originally specified, unless dimmed at time of power loss. Consult factory for EMC dimming override device.



For continuous rows longer than 8' one EPC/EMC will be located in the feed section (end-left) of the row as shown below.

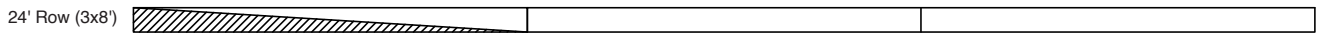

If two EPC/EMC's are required their default locations will be in the feed section (end-left) and last section (end-right) as below.

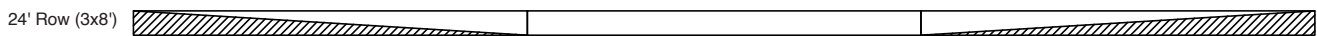

Custom placement of one or more EPC/EMC's must be clearly identified during ordering.



SENSORS (Integral) for individual fixtures will control entire length of fixture and will be located on feed end of fixture.



SENSORS for rows by default will control the feed section (end-left) of the row. Sensors can control more than an 8' section within a row. Consult factory for sensor/section options, or for multiple sensors in a continuous row.

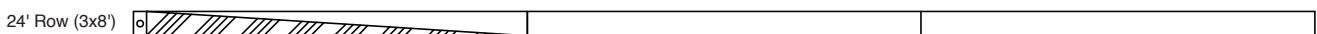

### Pattern Guide

Profile may be specified in patterns of virtually any configuration. All patterns and corners are continuously illuminated and joined with included aligner brackets and joining hardware. See examples below for suggestions with actual and nominal dimensions. Day-O-Lite's custom manufacturing capabilities allow the specification of custom angled connectors to make non-square patterns possible. (See ILX example below).

All corners and connectors are fully welded to ensure correct dimensions and "square" joinery when assembled.

### How to Specify

1. Submit your pattern to Day-O-Lite in dimensioned CAD file or submit a fully dimensioned PDF file.
2. If EPC/EMC or Sensors are to be included their location needs to be clearly noted.
3. Day-O-Lite will design your pattern to as close as is nominally possible given standard LED module lengths, including connectors.
4. Day-O-Lite will supply a detailed drawing for approval with final dimensions. All patterns must be approved prior to manufacture.

### Pattern Examples

### Illuminated Connectors

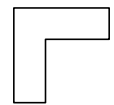
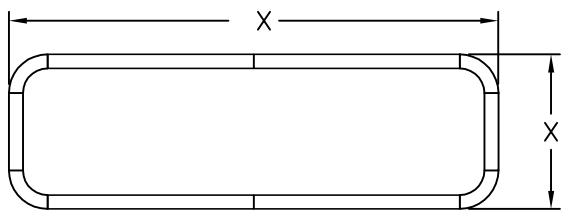
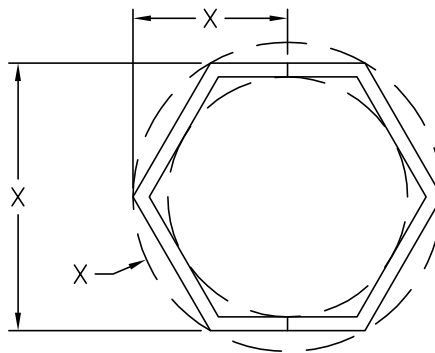
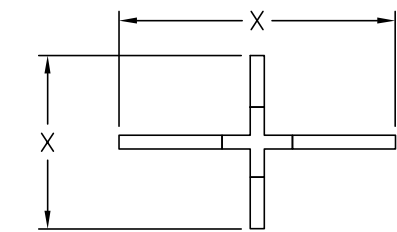
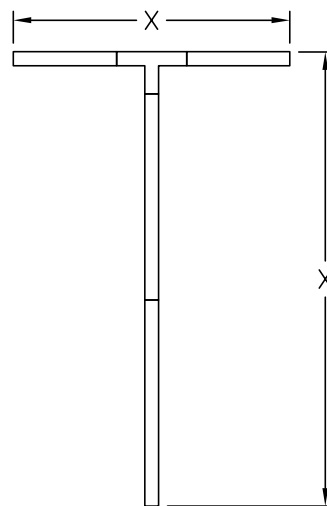
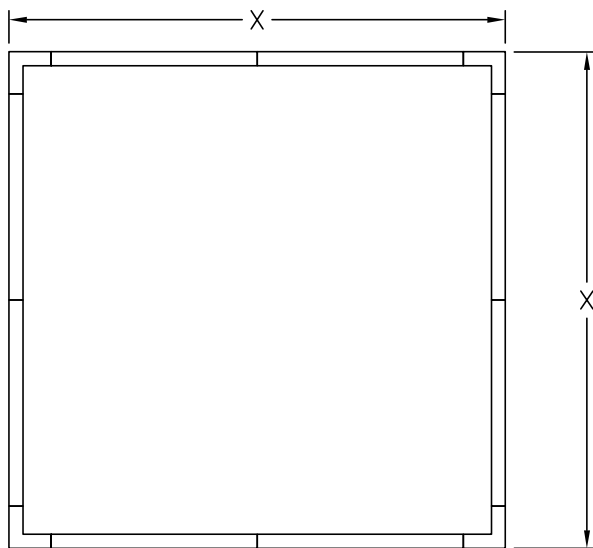

ILC2 = 90° Corner

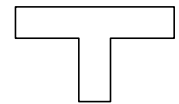

ILC3 = 90° Tee

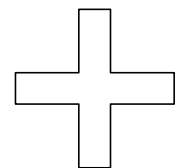

ILC4 = 90° Cross

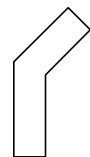

ILCX = X° Custom



ILCR = Custom Radius

## Trimless (TRL) Mounting

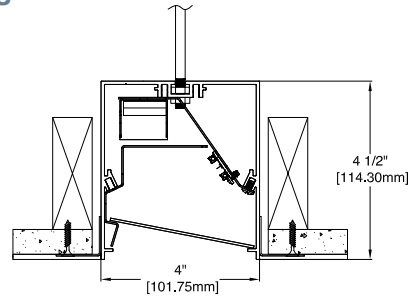

## Photometry

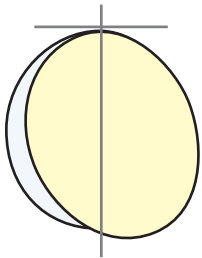

PRFL-44W-D-SI-40-**LO**-4

4000K CCT  
WATTS: 20  
LUMENS: 2095  
LPW: 105

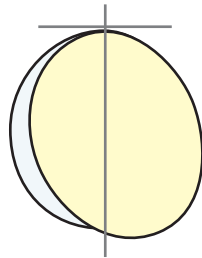

PRFL-44W-D-SI-40-**SO**-4

4000K CCT  
WATTS: 27  
LUMENS: 2794  
LPW: 103

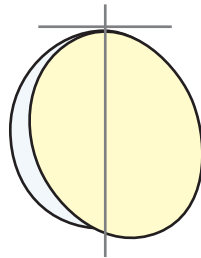

PRFL-44W-D-SI-40-**HO**-4

4000K CCT  
WATTS: 35  
LUMENS: 3490  
LPW: 100

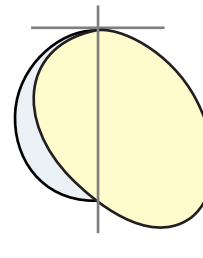

PRFL-44W-D-AS-**40**-SO-4

4000K CCT  
WATTS: 27  
LUMENS: 2772  
LPW: 103

4000K @ 80CRI, SI lens.

Use the following multipliers for other CCTs: 2700K x 0.94, 3000K x 0.96, 3500K x 0.98, 5000K x 1.02. IES files @ [www.dayolite.com](http://www.dayolite.com)

## Specifications

**CONSTRUCTION:** Extruded aluminum side housing. 20 gauge cold rolled steel top and internal components.

**REFLECTOR:** Highly reflective baked white enamel with pre-finished reflective LED tray.

**OPTICS:** Flush opal acrylic lens is standard.

**LED:** Static white LED modules in 30/35/40 & 50K CCT, 80/90CRI. Lumen maintenance minimum  $L_{70} = 50,000$  hours. 3 SDCM color consistency. BIOS SkyBlue, RGB, RGBW, RGBWW, Tunable White and Dim-to-Warm options available; field replaceable.

**DRIVER:** Standard driver is Class 2 AOC 0-10V to 1%, Dim-to-Off available. 120/277V input, PF > 90%, THD < 20 @ 120V. DMX, DALI & Lutron protocols available. All drivers prewired for connection to control system (by others); field replaceable.

**MOUNTING:** Standard installation is in dry wall ceiling via 1/4-20 rods (by others). Optional mounting yokes are available.

**FINISH:** Housing and components finished in baked white enamel.

**CERTIFICATION:** cETLus listed conforming to UL STD. 1598 and certified to CSA STD C22.2 NO. 250.0. Suitable for dry & damp locations. Union Made in the United States of America. I.B.E.W., BAA compliant, Declare Red List Approved.

**LEGAL:** Day-O-Lite, a division of SCW Corporation. All rights reserved. The Day-O-Lite logo is a registered trademark of SCW Corporation. Day-O-Lite reserves the right to change specifications without notice for product improvement.