

Date		Notes
Project		
Type	Qty	

Features

- Recessed linear wall washer.
- LED optimized optics for smooth, efficient illumination.
- Individual fixtures, continuous rows or custom patterns.
- Programmable driver for custom lumen packages.
- 0-10V dimming to 1% standard. Dim-to-off available.
- DMX, Lutron and DALI protocols also available.
- Sensor Ready for wireless Smart Lighting Solutions.
- 80/90CRI, Tunable White, RGBW & RGBWW.
- Bios SkyBlue™ circadian solutions available.

Declare Red List Approved.

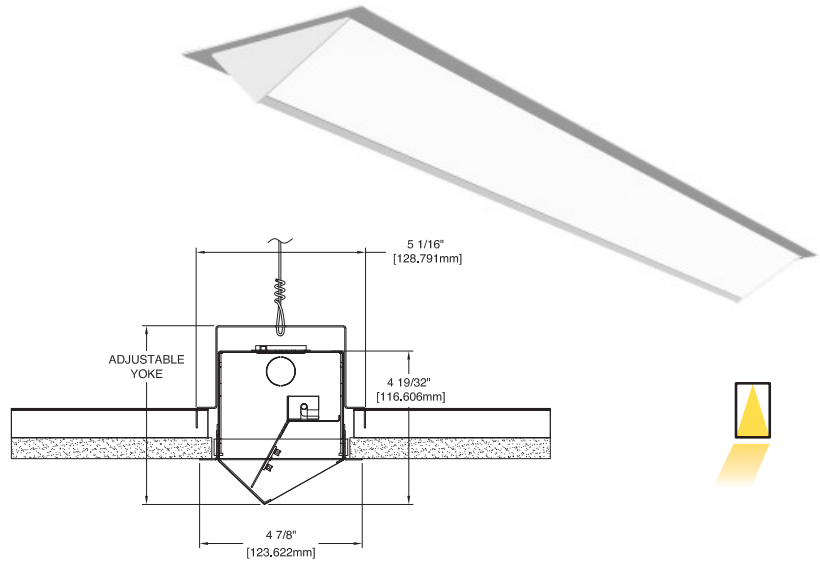

Ordering Guide



MODEL	OPTICS	CCT ¹	LUMENS ²	SIZE	MOUNTING ⁴	FINISH	OPTIONS
APL-1999-D	SI						
APL-1999-D Direct Wall Wash	SI = Satin Ice Acrylic	STATIC WHITE 27 = 2700K 30 = 3000K 35 = 3500K 40 = 4000K 50 = 5000K BIOS SkyBlue Spectrally optimized circadian solutions. TUNABLE WHITE (2700K-6500K) 2DIM10 = for 0-10V 2DMX = for DMX 2ESN = for Philips 2CAS = for Casambi 2LUT = for Lutron DIM-TO-WARM (2700K-6500K) DTW = Dim-to-Warm RGB + WHITE RGB = RGB RGBW = RGBW RGBWW = RGBWW	LO = 550/ft (5W/ft, 115LPW) SO = 750/ft (7W/ft, 114LPW) HO = 900/ft (9W/ft, 111LPW) CUSTOM For custom lumens specify value < HO.	2 = 2 ft 3 = 3 ft 4 = 4 ft 5 = 5 ft 6 = 6 ft 7 = 7 ft 8 = 8 ft For other enter row length (e.g. 48 = 48 ft)	G = Grid 15/16" T-Bar MG = Mini Grid 9/16" T-Bar SG = Slot Grid SGF = Slot Grid Flush XG = Interlude XGF = Interlude Flush TGF = Tegular Flush 15/16" T-Bar XGF = Tegular Flush 9/16" T-Bar ACY = Aircraft "Y" Cable S = Surface F = Flanged	W = White CC = Custom Color AMW = Anti Microbial White	DIMMING DRIVERS DIM10 = 0-10V (1%) Standard DTO = 0-10V (Dim-to-Off) DIMST = 0-10V Step Dimming DIMSR = DALI Sensor Ready (5.0%) DALI = DALI (5.0%) DMX = DMX LUTRON™ DIMMING DRIVERS LDE1 = Hi-Lume 1% EcoSystem LD2 = Digital 1% (DALI-2) L3DA3W = Hi-Lume 1% 3-Wire SENSORS & CONTROLS⁴ AVO = Avi-On Sensor AWNS = Lutron Athena Sensor ESN = EasySense Sensor CAS = Casambi Wireless Control EMERGENCY & OTHER⁵ EMC = Emergency Circuit GTD = Generator Transfer Device EPC4 = 4W Emergency Battery EPC6 = 6.5W Emergency Battery EPC10 = 10W Emergency Battery EPC12 = 12W Emergency Battery WIRING & OTHER FWH = Flexible Wiring Harness DWH = DMX Wiring Harness

¹All LED, BIOS, Tunable White, DTW, and RGB/W options and Ordering Codes page 2.

²Lumens at 80CRI, 4000K, SI lens. Photometry page 4.

³See page 4 for mounting option details.

⁴All Sensor & Control options page 2.

⁵EPC6 is standard unless otherwise specified. EPC not for DMX drivers.

BAA letter of compliance available at www.dayolite.com.

LED, BIOS, Sensor & Control Ordering Codes

LED

Static White

30 = 3000K 80 CRI
35 = 3500K 80 CRI
40 = 4000K 80 CRI
50 = 5000K 80 CRI

927 = 2700K 90 CRI
930 = 3000K 90 CRI
935 = 3500K 90 CRI
940 = 4000K 90 CRI

Tunable White¹ (2700K-6500K)

2DIM10 = 0-10V 80 CRI
2DMX = DMX 80 CRI
2CAS = Casambi Wireless 80 CRI
2ESN = Philips EasySense 80 CRI
2LUT = Lutron (LD2) 80 CRI

92DIM10 = 0-10V 90 CRI
92DMX = DMX 90 CRI
92CAS = Casambi Wireless 90 CRI
92ESN = Philips EasySense 90 CRI
92LUT = Lutron (LD2) 90 CRI

Dim-to-Warm²

DTW = 6500K-2700K 80 CRI
9DTW = 6500K-2700K 90 CRI

RGB/W³ (DMX driver standard)

RGB = RGB only
RGB27 = RGB w/2700K
RGB30 = RGB w/3000K
RGB35 = RGB w/3500K
RGB40 = RGB w/4000K
RGB50 = RGB w/5000K
RGBWW = RGB w/2700K-6500K

Single Color

RED = Red
BLU = Blue
GRN = Green
AMB = Amber

BIOS SkyBlue

BIOS SkyBlue biological technology brings the benefits of blue skies inside. BIOS SkyBlue is the only spectrally optimized circadian solution to target the region that drives wellness benefits including increased alertness, enhanced productivity, better mood, and better sleep. More information may be found at www.bioslighting.com or by contacting Day-O-Lite directly. All options for 0-10V control.

BIOS Biological Static

For daytime applications. BIOS Static Biological LED features key BIOS SkyBlue (490nm) for maximum daytime circadian impact.

B30 = 3000K
B35 = 3500K
B40 = 4000K

BIOS Biological Dynamic White

Designed to transition from daytime to evening in a dim-to-warm protocol. The daytime CCT includes full BIOS SkyBlue (490nm) for maximum daytime circadian impact, while the evening spectrum removes BIOS SkyBlue for minimal circadian stimulus after hours.

B30D = 3000K-2700K
B35D = 3500K-3000K
B40D = 4000K-3500K

BIOS Biological Tunable White

Designed to transition from daytime to evening in a tunable white protocol. The daytime CCT includes full BIOS SkyBlue (490nm) for maximum daytime circadian impact, while the evening spectrum removes BIOS SkyBlue for minimal circadian stimulus after hours.

B30T = 3000K-2700K
B35T = 3500K-2700K
B40T = 4000K-2700K

Sensors & Controls

Sensors*

AVO = Avi-On Occ/Day
AVM = Avi-On Occ (Microwave)
BNV = BubblyNet Occ/Day
ENC = Encelium Occ/Day
ENL = EnLighted Occ/Day/Temp
LEG = Legrand Occ/Day
ANW = Lutron Athena Occ/Day
VIVE = Lutron Vive Occ/Day
NLT = Acuity nLight Occ/Day
NXC = Current NX Occ/Day
ESN = Philips EasySense Occ/Day
WVL = Cooper WaveLinx Occ/Day

Wireless Control

CAS = Casambi

Sensors and control options to be commissioned wirelessly in the field by qualified controls personnel with applicable apps (by others).

Other Options

Other sensor and wireless control options are available. Contact factory for details.

¹Tunable white may be controlled by a number of dimming protocols as shown.

²Dim-to-Warm mimics incandescent dimming by warming the CCT from 6500K to 2700K as light levels are dimmed.

³All RGB, RGBW and RGBWW options for DMX control (by others). 80 CRI standard.

Individual Fixtures & Continuous Rows

NOMINAL LENGTH	GRID O.C.
2'	24"
4'	48"
6'	72"
8'	96"
12'	144"
16'	192"
20'	240"
24'	288"

Individual fixtures and rows are continuously illuminated and joined with included aligner brackets and hardware.

Individual fixtures up to 8' nominal and continuous rows up to 24' nominal are dimensioned as shown below. Continuous rows longer than 8' and patterns including EPC/EMC locations must be approved prior to manufacturing.

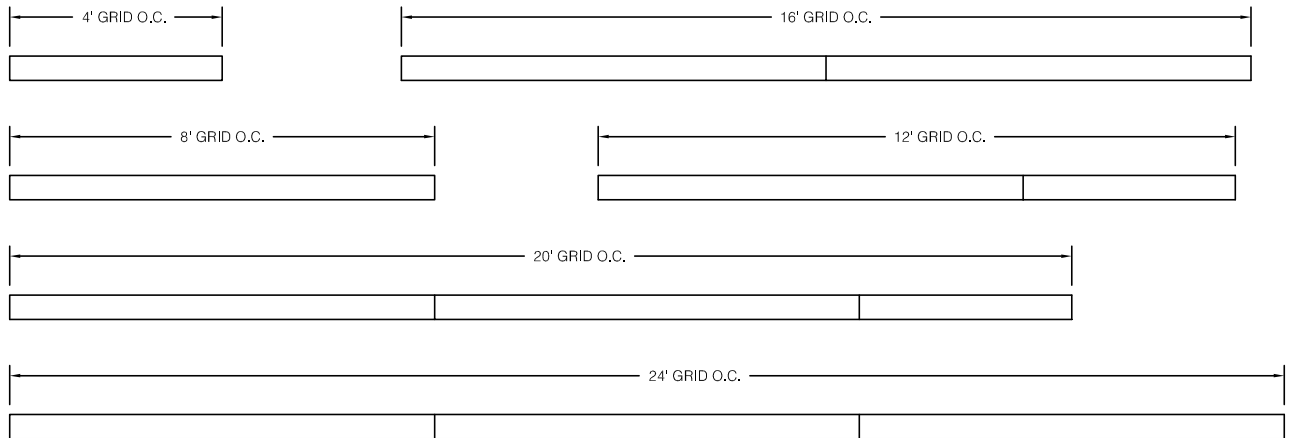

Emergency & Sensor Locations

EPC will control entire length of individual fixtures. Individual fixtures of differing lengths will deliver the same lumens under EPC power (a 4' fixture will deliver the same total lumens over half the length of an 8' fixture). EMC controlled individual fixtures will deliver lumens per foot as originally specified, unless dimmed at time of power loss. Consult factory for EMC dimming override device.



For individual fixtures to 8' EPC/EMC will power entire fixture.

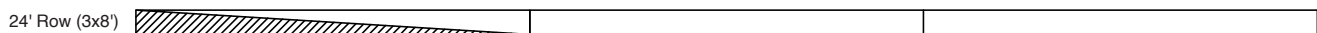

For continuous rows longer than 8' one EPC/EMC will be located in the feed section (end-left) of the row as shown below.

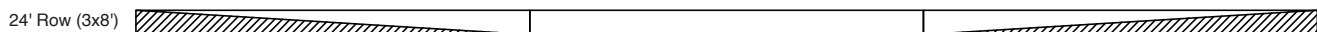

If two EPC/EMC's are required their default locations will be in the feed section (end-left) and last section (end-right) as below.



Custom placement of one or more EPC/EMC's must be clearly identified during ordering.



SENSORS (Integral) for individual fixtures will control entire length of fixture and will be located on feed end of fixture.

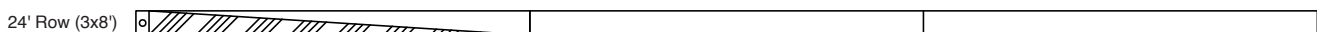

SENSORS for rows by default will control the feed section (end-left) of the row. Sensors can control more than an 8' section within a row. Consult factory for sensor/section options, or for multiple sensors in a continuous row.

Additional Grid Mounting Options

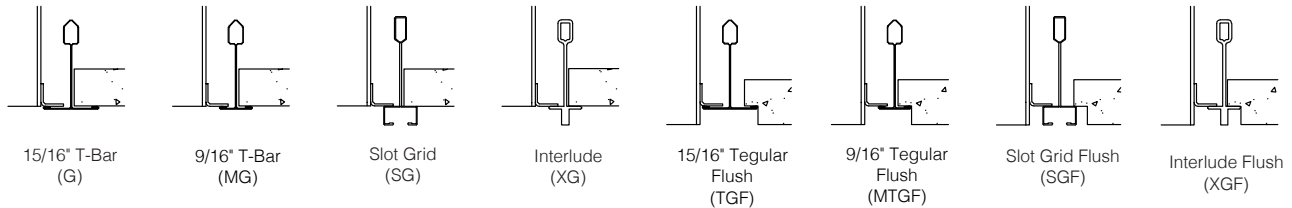

Adjustable LED Tray

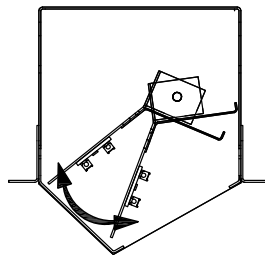

Internal LED tray adjusted up to 30 degrees for aiming.

Photometry

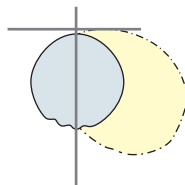

APL-1999-D-SI-40- LO -4	APL-1999-D-SI-40- SO -4	APL-1999-D-SI-40- HO -4
4000K CCT	4000K CCT	4000K CCT
WATTS: 20	WATTS: 27	WATTS: 35
LUMENS: 2300	LUMENS: 3095	LUMENS: 3869
LPW: 115	LPW: 114	LPW: 111

4000K @ 80CRI, 4', WRA lens.

Use the following multipliers for other CCTs: 2700K x 0.94, 3000K x 0.96, 3500K x 0.98, 5000K x 1.02. IES files @ www.dayolite.com

Specifications

HOUSING: Die-formed, 20-gauge, cold rolled steel. Bottom of housing is lensed with an angular reflector for asymmetrical distribution.

REFLECTOR: Reflector assembly is die-formed 20-gauge, cold rolled steel finished in baked white enamel applied over a five-stage process.

SHIELDING: Satin Ice acrylic is standard. Shatter resistant polycarbonate is also available.

LED Static white LED modules in 27/30/35/40 & 50K CCT, 80/90CRI. Lumen maintenance minimum L_{70} = 50,000 hours. 3 SDCM color consistency. BIOS SkyBlue, RGB, RGBW and Tunable White and options available.

DRIVER: Standard driver is Class 2 AOC 0-10V to 1%, 120/277V input, PF > 90%, THD < 20 @ 120V. Additional dimming protocols available. All drivers prewired from factory for connection to control system (by others). Field replaceable.

MOUNTING: Standard installation is in inverted T-bar ceiling. Optional trims are available for installations of 9/16" inverted T-bar and a miniature grid. Mounting brackets are provided with each fixture.

FINISH: Fixture housing and steel components are finished in baked white enamel applied over a five-stage pretreatment process.

CERTIFICATION: cETLus listed conforming to UL STD. 1598 and certified to CSA STD C22.2 NO. 250.0. Suitable for dry & damp locations. Union Made in the United States of America, I.B.E.W, BAA compliant, Declare Red List Approved.

LEGAL: Day-O-Lite, a division of SCW Corporation. All rights reserved. The Day-O-Lite logo is a registered trademark of SCW Corporation. Day-O-Lite reserves the right to change specifications without notice for product improvement.