

Program Outline

RapidSHIP products are estimated to ship 10 business days or less from the morning the order is received and confirmed. Linear rows will ship 10 business days or less from the day the layout drawings are approved. Orders confirmed and layouts approved after 12:00 p.m. Eastern Time are estimated to ship 10 days or less from the following business morning. All incoming orders must be clearly marked "*RapidSHIP*". Orders not marked will not qualify for *RapidSHIP* processing. Please refer to complete program [Terms & Conditions](#)¹ for details and restrictions.

Applicable Products

The products and options shown below qualify for the Day-O-Lite *RapidSHIP* program. Simply configure a catalog number using any of the options below and your order will qualify for *RapidSHIP* processing. Please refer to the individual product specification sheets at www.dayolite.com for further details about each product.

Profile 24

Profile 44

Harmony Lensed Troffer

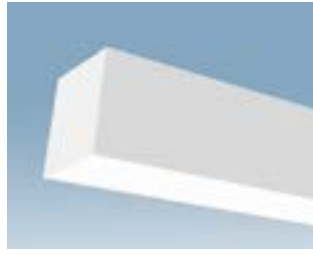
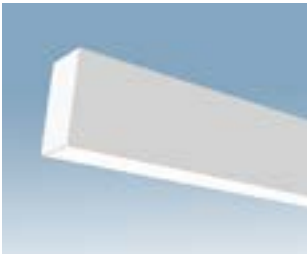

MODEL	PRFL = Profile
STYLE	24 = 2 3/4" wide 44 = 4" wide
DISTRIBUTION	D = Direct DI = Direct/Indirect
SHIELDING	FL = Flush Opal Acrylic
CCT	30 = 3000K 35 = 3500K 40 = 4000K
LUMENS²	LO = Low Output SO = Standard Output HO = High Output
SIZE²	4 = 4' Nominal 8 = 8' Nominal
MOUNTING	AC = Aircraft Cable (48") G = 15/16" Grid MG = 9/16" Mini Grid SG = 9/16" Slot Grid
FINISH	W = White
OPTIONS	DIM10 = 0-10V Dimming 1% EPC5 = 5W Emergency Battery Pack
QUANTITIES	400' Continuous Row Max 50 Individual Max

MODEL	HML-A (Angled Lens)
STYLE	A = Angled Side Lenses
DISTRIBUTION	D = Direct
SHIELDING	SI = Satin Ice Acrylic
CCT	30 = 3000K 35 = 3500K 40 = 4000K
LUMENS³	LO = Low Output SO = Standard Output HO = High Output
SIZE³	22 = 2X2 14 = 1X4 24 = 2X4
MOUNTING	G = 15/16" Grid MG = 9/16" Mini Grid SG = 9/16" Slot Grid
FINISH	W = White
OPTIONS	DIM10 = 0-10V Dimming 1% EPC5 = 5W Emergency Battery Pack
QUANTITIES	50 Individual Max

¹ For complete Terms & Conditions see page 4.

² For actual Profile dimensions, lumens and mounting options see page 2.

³ For actual Harmony dimensions, lumens and mounting options see page 3.



Profile Suspended Sections & Lumens

NOMINAL LENGTH	SECTIONS	ACTUAL LENGTH	SUSP. 1 O.C.	SUSP. 2 O.C.	SUSP. 3 O.C.
4'	4'	44 1/2"	41 1/2"		
8'	8'	89"	86"		
12'	8' + 4'	133 1/2"	86"	44 1/2"	
16'	8' + 8'	178"	86"	89"	
20'	8' + 8' + 4'	222 1/2"	86"	89"	44 1/2"

PRFL-24	LUMENS	LPW
LO	570/ft	115
SO	760/ft	108
HO	900/ft	100

PRFL-44	LUMENS	LPW
LO	600/ft	120
SO	800/ft	114
HO	1000/ft	111

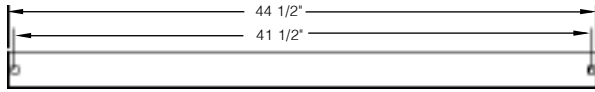

Dimensions shown are for suspended and surface mount configurations. Fixtures are continuously illuminated along entire length. Rows are continuously illuminated and joined with included aligner bracket and hardware.

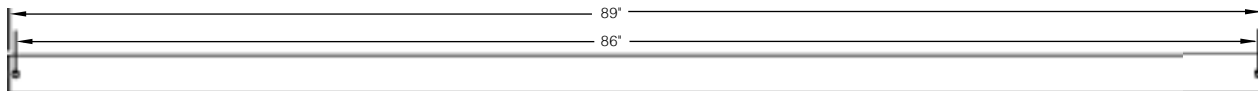

Profile Grid Ceiling Sections and Lumens

NOMINAL LENGTH	SECTIONS	GRID O.C. LENGTH
4'	4'	48"
8'	8'	96"
12'	8' + 4'	144"
16'	8' + 8'	192"
20'	8' + 8' + 4'	240"

PRFL-24	LUMENS	LPW
LO	570/ft	115
SO	760/ft	108
HO	900/ft	100

PRFL-44	LUMENS	LPW
LO	600/ft	120
SO	800/ft	114
HO	1000/ft	111



Dimensions shown are for fixtures mounted in Grid, Mini-Grid or Slot Grid ceilings. Individual fixtures and rows are continuously illuminated and joined with included aligner brackets and hardware.

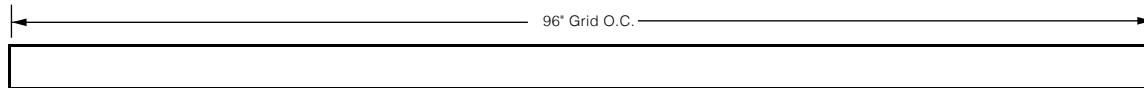

Profile Grid Ceiling Mounting Options

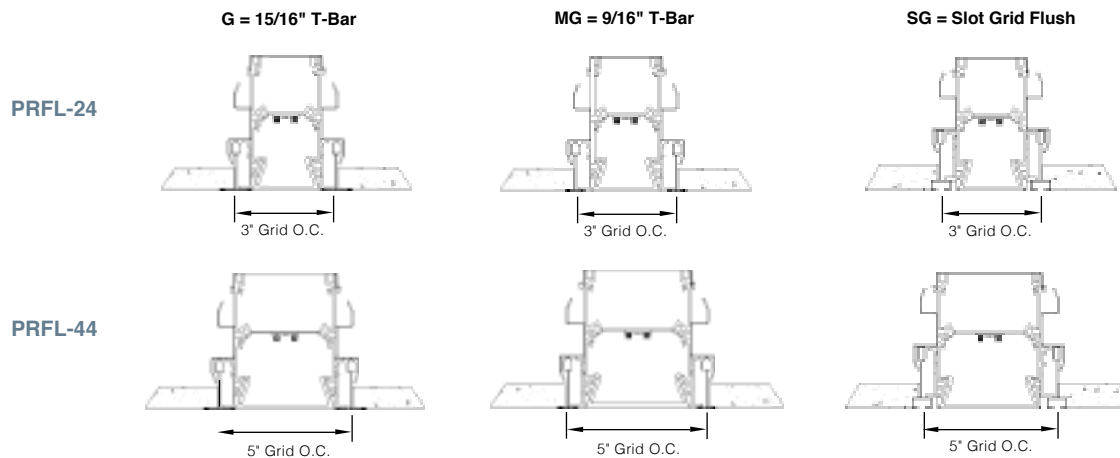

Harmony Lumens and Mounting

HML-22	LUMENS	LPW
LO	2550	127
SO	3400	120
HO	4700	124

HML-24	LUMENS	LPW
LO	5100	127
SO	6800	120
HO	9400	124

HML-14	LUMENS	LPW
LO	4200	105
SO	5700	102
HO	7900	104

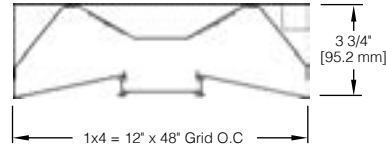
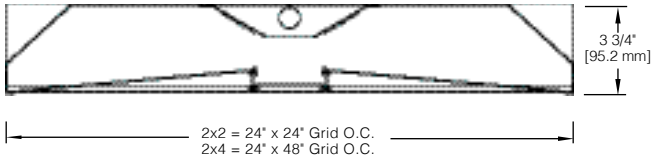

Mounting Options

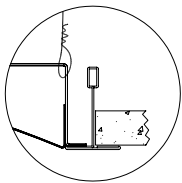

G = 15/16" T-Bar

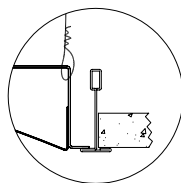

MG = 9/16" T-Bar

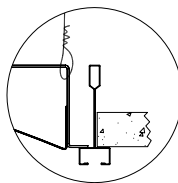

SG = Slot Grid

RapidSHIP Terms & Conditions

All orders must be clearly marked "*RapidSHIP*". Orders not marked will not qualify for *RapidSHIP* processing.

All orders must ship to a single location. Drop shipments to multiple locations not allowed.

Individual products are estimated to ship 10 business days or less from the morning a clean order is received and confirmed.

Continuous linear rows are estimated to ship 10 business days or less from the day the order is confirmed and layout drawings are approved.

Orders confirmed and layouts approved after 12:00 p.m. Eastern Time are estimated to ship 10 days or less from the following business morning.

A maximum of 50 units of individual products of the same catalog number are allowed. The maximum quantity of continuous linear product of the same catalog number is 400'. Continuous linear rows must be straight runs.

RapidSHIP processing is available for the products and options listed in this guide only. Please contact the factory or www.dayolite.com for information on Day-O-Lite's complete line of architectural luminaires.

Orders received after 3:00 p.m. Eastern Time, or on weekends or holidays will be processed the next business day. Standard shipping terms apply. Freight allowed for all orders over \$5,000. Orders subject to credit approval.

Changes or cancellations may not be made after the order has been acknowledged and released to factory.

Day-O-Lite is not responsible for elements outside its control, i.e., inclement weather, third party shipping issues or industry wide component shortages.

Visit www.dayolite.com or contact Day-O-Lite at (401) 467-8232 for additional information on *RapidSHIP* eligible products, as well as Day-O-Lite's complete offering of LED and fluorescent luminaires.

Terms & Conditions subject to change at the discretion of Day-O-Lite.