

Date	Notes
Project	
Type	Qty

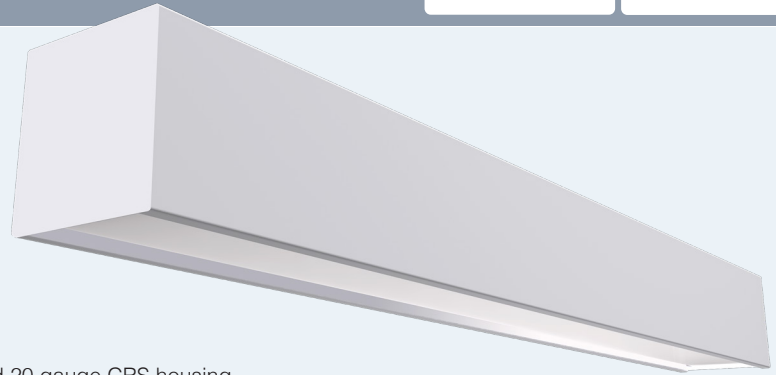
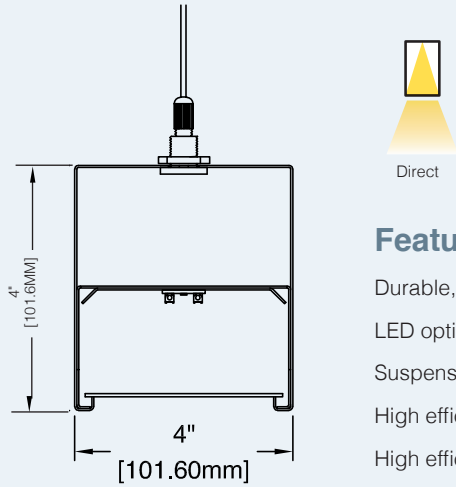

Features

- Durable, welded 20 gauge CRS housing.
- LED optimized optics for smooth illumination end-to-end.
- Suspension mount for individual fixtures, continuous runs or custom patterns.
- High efficiency programmable driver for custom lumen packages. 0-10V dimming to 1% standard.
- High efficacy LEDs in 80 or 90 CRI; two or three channel tunable white; five channel tunable color.

Ordering Guide

MODEL	OPTICS	CCT ¹	LUMENS ²	LENGTH ³	MOUNTING	FINISH	OPTIONS
PTPL-44-D	SI						
PTPL-44-D Direct	SI = Satin Ice Acrylic (lay-in)	27 = 2700K 80CRI 30 = 3000K 80CRI 35 = 3500K 80CRI 40 = 4000K 80CRI 50 = 5000K 80CRI 90 CRI add '9' Ex: 940 = 4000K @ 90 CRI	LO = 625/ft (5W/ft, 114LPW) SO = 800/ft (7W/ft, 114LPW) HO = 1000/ft (9W/ft, 110LPW) Consult factory for additional lumen packages. All values nominal.	2 = 2 ft 3 = 3 ft 4 = 4 ft 5 = 5 ft 6 = 6 ft 7 = 7 ft 8 = 8 ft For other enter row length (e.g. 48 = 48 ft)	AC = Aircraft Cable PD = Pendant Stem G = Grid F = Flange S = Surface Mount WM = Wall Mount	W = White CC = Custom Color AMW = Anti-Microbial White	DIMMING DRIVERS DIM10 = 0-10V (1%) - Standard DIMSR = 0-10V (5.0%) Sensor Ready DIMST = Step Dimming (40%/100%) DALI = DALI (5.0%) LUTRON™ DIMMING DRIVERS LDE1 = Hi-Lume™ 1% EcoSystem™ LDE5 = 5-Series 5% EcoSystem™ L3DA3W = Hi-Lume™ 1% 3-Wire LTEA2W = Hi-Lume 1% 2-Wire 120V SENSORS & CONTROLS ESN = Philips™ EasySense DAY = Daylight Harvesting OCC = Occupancy Sensor CAS = Casambi Bluetooth control VDO = Vive Sensor by Lutron EMERGENCY EMC = Emergency Circuit GTD = Generator Transfer Device EPC4 = 4W Emergency Battery Pack EPC7 = 7W Emergency Battery Pack EPC10 = 10W Emergency Battery Pack EPC12 = 12W Emergency Battery Pack
		TUNABLE WHITE & COLOR¹ <u>2-Channel White</u> 2DIM10 = for 0-10V 2DALI = for DALI 2DMX = for DMX 2PSQ = for Lutron 2SNS = for Signify 2CAS = for Casambi <u>3-Channel White</u> 3DML = for DLM <u>3-Channel Color</u> RGB <u>4-Channel Color/White</u> RGBW <u>5-Channel Color/Warm White/Cool White</u> RGBWW					

¹Tunable white, tunable color and RGB/W options detailed on page 5.

²Delivered Lumens are Standard Output (SO) and Low Output (LO) at 80+CRI 4000K CCT. Use the following multiplier to estimate delivered lumens at other CCTs: 2700K = 0.94, 3000K = 0.96, 3500K = 0.98, 5000K = 1.02. All values nominal. See page 3 for photometry.

³See page 2 for actual fixture lengths and suspension locations.

⁴See page 4 for suspension details.



Individual Fixtures & Continuous Rows

NOMINAL LENGTH	ACTUAL LENGTH	SUSP. 1 O.C.	SUSP. 2 O.C.	SUSP. 3 O.C.
4'	3' 8-1/2"	41 1/2"		
8'	7' 5"	86		
12'	11' 1-1/2"	86	44 1/2"	
16'	14' 10"	86	89	
20'	18' 6-1/2"	86	89	44 1/2"
24'	22' 3"	86	89	89

Individual fixtures and rows are continuously illuminated and joined with included aligner brackets and hardware. Power feed locations and mounting locations are shown below.

Continuous rows longer than 8' and patterns, including EPC/EMC and sensor locations must be approved prior to manufacturing. See below for specifying patterns.

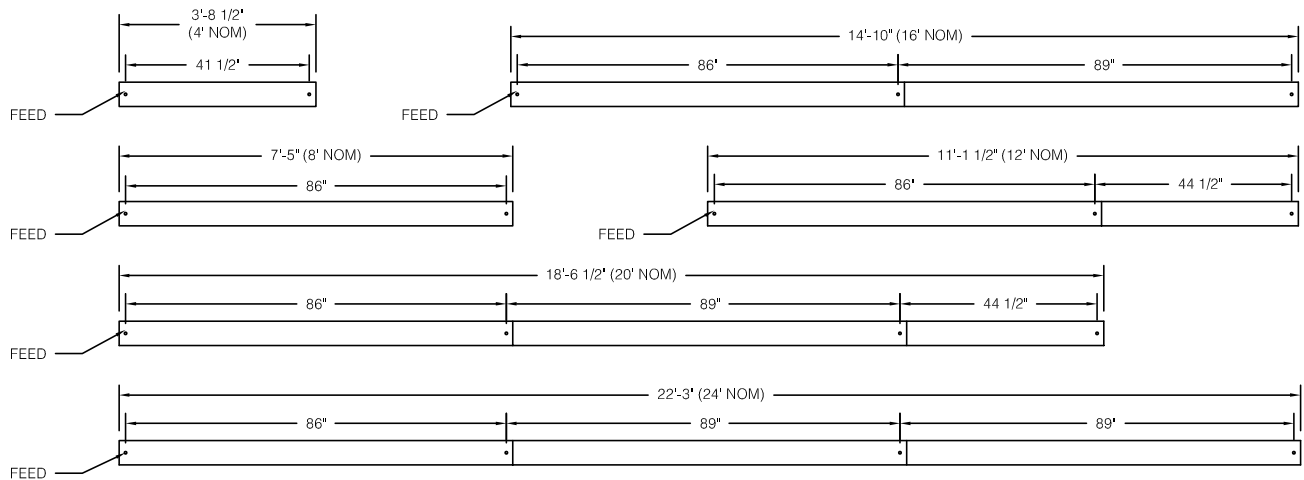

Emergency & Sensor Locations

EPC will control entire length of individual fixtures. Individual fixtures of differing lengths will deliver the same lumens under EPC power (a 4' fixture will deliver the same total lumens over half the length of an 8' fixture). EMC controlled individual fixtures will deliver lumens per foot as originally specified, unless dimmed at time of power loss. Consult factory for EMC dimming override device.



For individual fixtures to 8' EPC/EMC will power entire fixture.

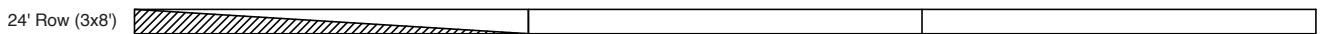

For continuous rows longer than 8' one EPC/EMC will be located in the feed section (end-left) of the row as shown below.

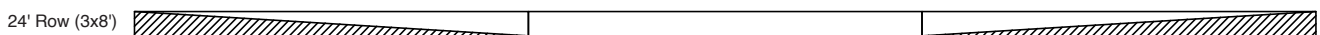

If two EPC/EMC's are required their default locations will be in the feed section (end-left) and last section (end-right) as below.



Custom placement of one or more EPC/EMC's must be clearly identified during ordering.



SENSORS (Integral) for individual fixtures will control entire length of fixture and will be located on feed end of fixture.

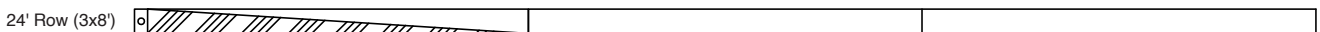

SENSORS for rows by default will control the feed section (end-left) of the row. Sensors can control more than an 8' section within a row. Consult factory for sensor/section options, or for multiple sensors in a continuous row.

Pattern Guide

This product may be specified in patterns of virtually any configuration. All patterns and corners are continuously illuminated and joined with included aligner brackets and joining hardware. See examples below for suggestions with actual and nominal dimensions. Day-O-Lite's custom manufacturing capabilities allow the specification of custom angled connectors to make non-square patterns possible. (See ILX example below).

All corners and connectors are fully welded to ensure correct dimensions and "square" joinery when assembled.

How to Specify

1. Submit your pattern to Day-O-Lite in dimensioned CAD file or submit a fully dimensioned PDF file.
2. If EPC/EMC or Sensors are to be included their location needs to be clearly noted.
3. Day-O-Lite will design your pattern to as close as is nominally possible given standard LED module lengths, including connectors.
4. Day-O-Lite will supply a detailed drawing for approval with final dimensions. All patterns must be approved prior to manufacture.

Pattern Examples

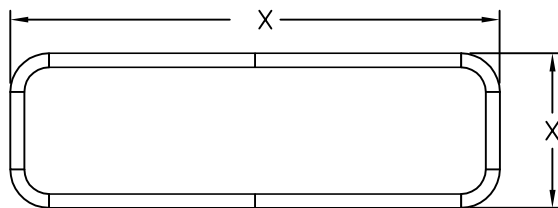
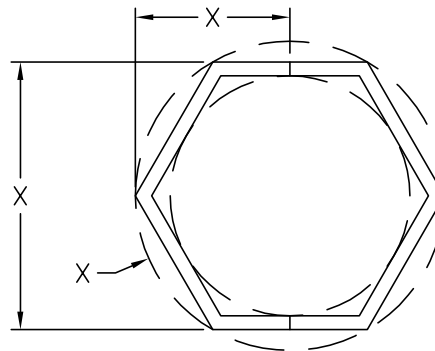
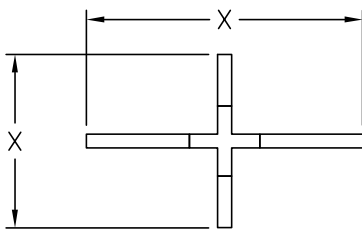
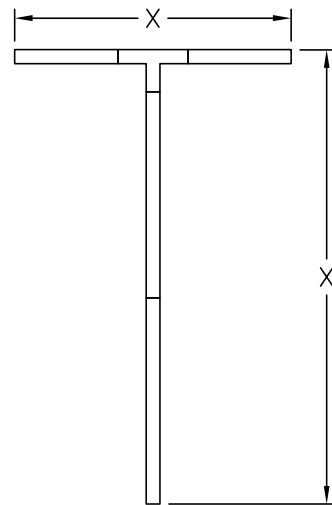
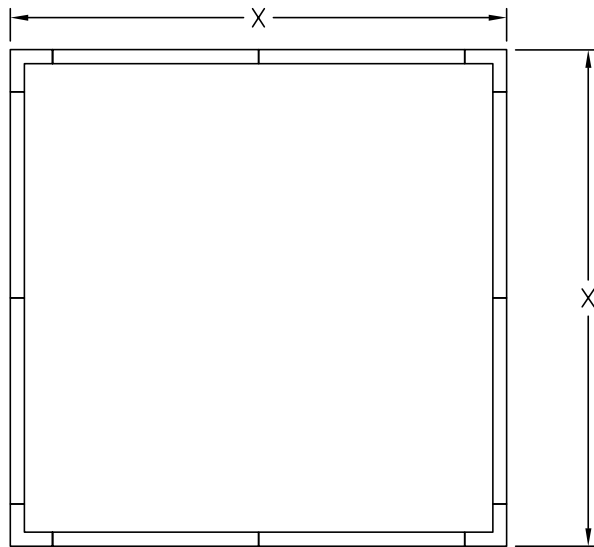

Illuminated Connectors

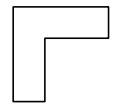

ILC2 = 90° Corner

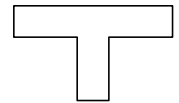

ILC3 = 90° Tee

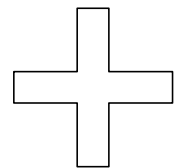

ILC4 = 90° Cross

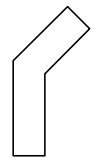

ILCX = X° Custom



**ILCR = Custom Radius
12" Min.**

Standard Suspensions

Standard suspension options include adjustable self-locking aircraft cables (AC) and rigid pendant stems (PD). AC assembly is 48" x 1/16" with a 5" feed canopy and 2" suspension canopies. 60" 18 gauge power and 22 gauge dimming control SJT feed.

PD assemblies are 5/8" dia. (or 3/8" IP) hollow stem for power feed by others, 24" is standard. Consult factory for longer suspension lengths and other mounting options.

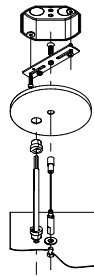

AC = Aircraft Cable

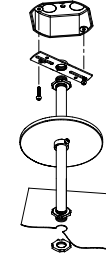
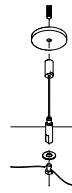

PD = Pendant Stem

Photometry

PTPL-44-D-SI-40-LO-4
Satin Ice Lens (SI)

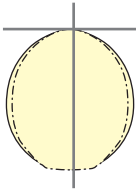

4000K CCT
WATTS: 21
LUMENS: 2400
LPW: 114
Distribution:
100% Direct

PTPL-44-D-SI-40-SO-4
Satin Ice Lens (SI)

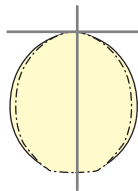

4000K CCT
WATTS: 28
LUMENS: 3200
LPW: 114
Distribution:
100% Direct

Specifications

CONSTRUCTION Die-formed steel housing. Joiner ends are notched for continuous appearance in row-mounted applications.

REFLECTOR Die-formed steel finished in highly reflective baked white enamel with pre-finished reflective LED tray.

OPTICS LED optimized Satin Ice (SI) acrylic regressed lens.

LED LED modules in 30/35/40 & 50K CCT, 80/90CRI. Lumen maintenance minimum $L_{70} = 50,000$ hours. 3 SDCM color consistency.

DRIVER Standard driver is Class 2 AOC 0-10V to 1%, 120/277V input, PF > 90%, THD < 20 @ 120V. Additional dimming protocols available. All drivers prewired from factory for connection to control system (by others). Field replaceable.

MOUNTING Standard options include adjustable self-locking aircraft cables (AC), and rigid pendant stems (PD). AC assembly is 48" x 1/16" with a 5" feed canopy and 2" suspension canopies. 18 gauge power and 22 gauge dimming control SJT feed.

FINISH Housing and components finished in baked white enamel. Canopies and pendant stems are white enamel unless otherwise specified.

CERTIFICATION Luminaires are cETLus listed conforming to UL STD. 1598 and certified to CSA STD C22.2 NO. 250.0. Suitable for dry locations. Union Made in the United States of America. I.B.E.W. RoHS compliant.

Day-O-Lite offers a variety of tunable white and tunable color options for a range of human centric applications and budgets. It is recommended that a recognized authority on the benefits and best practices of tunable white be consulted prior to specification. As a rule, fewer channels will provide a basic level of performance for budget conscious applications. Conversely, an increased number of channels, a wider CCT range, higher CRI and more precise color consistency may be more appropriate depending on the application and desired results.

HOW TO SPECIFY

Select from the various channel/control options below and insert desired **Ordering Code** into the **COLOR TEMP** column of the Ordering Guide on page 1. No need to add a dimming option as the codes include the chosen protocol.

2-CHANNEL TUNABLE WHITE OPTIONS

2700K - 6500K CCT range
 1000L/ft LED modules @ 4000K
 80+ CRI w/3SDCM color accuracy
 10W/ft. nominal power

Ordering Codes

2DIM10 for 0-10V control
2DALI for DALI control
2DMX for DMX control
2PSQ for Lutron Quantum control
2SNS for control via Signify SNS sensors
2CAS for control via Casambi BLE wireless devices

LEGRAND BLANCO MULTI-CHANNEL OPTIONS

Blanco-2

Blanco-2 mixes two channels of white LEDs to approximate the blackbody curve for tunable white applications. CCT and intensity may be adjusted with controls by others.

3000K-5000K CCT range
 1000L/ft LED modules @ 4000K
 90+ CRI w/2SDCM color accuracy
 10W/ft. nominal power

Ordering Codes

B2DLM for DLM control

Blanco-3

Blanco-3 mixes three channels of white LEDs across a wider range of color temperatures for more demanding tunable white applications. CCT and intensity may be adjusted with controls by others.

2700K-6500K CCT range
 1000L/ft. LED modules @ 4000K
 90+ CRI w/SDCM color accuracy
 10W/ft. nominal power

Ordering Codes

B3DLM for DLM control

RGB & RGBW TUNABLE COLOR

RGB = Red, Green, Blue color mixing LEDs
 RGB/W = Red, Green, Blue + White of chosen CCT
 Dimming from 100% to 1%.
 90+ CRI w/3SDCM color accuracy
 10W/ft. nominal power

Notes:

RGB requires an RGB DMX or DALI controller (by others)

RGBW requires an RGBW DMX or DALI controller (by others)

All channels on one driver is standard, if isolating the White from the RGB channels is desired please consult factory.

RGB and RGBW are not recommended for tunable white applications.

Ordering Codes

RGB for DMX control
RGB27 for DMX control w/2700K white
RGB30 for DMX control w/3000K white
RGB35 for DMX control w/3500K white
RGB40 for DMX control w/4000K white
RGB50 for DMX control w/5000K white
RGB65 for DMX control w/6500K white
 Add Suffix **DAL** for DALI Control to codes above.

5-CHANNEL TUNABLE WHITE AND COLOR

RGBWW = Red, Green, Blue, Warm White, Cool White.
 Consult factory for RGBWW tunable white/color options.

Day-O-Lite makes no claims as to the psychological or physiological efficacy of the white color tuning options offered herein.